

Pioneer *sound.vision.soul*

**AUDIO/VIDEO MULTI-CHANNEL
RECEIVER**

VSX-D412

VSX-D512

Operating Instructions

WARNING: THE APPARATUS IS NOT WATERPROOFS, TO PREVENT FIRE OR SHOCK HAZARD, DO NOT EXPOSE THIS APPLIANCE TO RAIN OR MOISTURE AND DO NOT PUT ANY WATER SOURCE NEAR THIS APPARATUS, SUCH AS VASE, FLOWER POT, COSMETICS CONTAINER AND MEDICINE BOTTLE ETC.

H001AE_n

[For Canadian model]

CAUTION: TO PREVENT ELECTRIC SHOCK, DO NOT USE THIS (POLARIZED) PLUG WITH AN EXTENSION CORD, RECEPTACLE OR OTHER OUTLET UNLESS THE BLADES CAN BE FULLY INSERTED TO PREVENT BLADE EXPOSURE.

ATTENTION: POUR PREVENIR LES CHOCES ELECTRIQUES NE PAS UTILISER CETTE FICHE POLARISEE AVEC UN PROLONGATEUR UNE PRISE DE COURANT OU UNE AUTRE SORTIE DE COURANT, SAUF SI LES LAMES PEUVENT ETRE INSEREES A FOND SANS EN LAISSER AUCUNE PARTIE A DECOUVERT.

H007A2L

[For Canadian model]

This Class B digital apparatus complies with Canadian ICES-003.

[Pour le modèle Canadien]

Cet appareil numérique de la classe B est conforme à la norme NMB-003 du Canada.

H009 2L

If the socket outlets on the associated equipment are not suitable for the plug supplied with the product, the plug must be removed and an appropriate one fitted. Replacement and mounting of an AC plug on the power supply cord of this unit should be performed only by qualified service personnel. The cut-off plug must be disposed of as an electrical shock hazard could exist if connected to a socket outlet.

H022AE_n

[For U.S. model]



ENERGY STAR® and the ENERGY STAR certification mark are registered US marks.

K001A_En

CAUTION:

THE STANDBY/ON BUTTON IS SECONDARY CONNECTED AND THEREFORE DOES NOT SEPARATE THE UNIT FROM MAINS POWER IN STANDBY POSITION. THEREFORE INSTALL THE UNIT SUITABLE PLACES EASY TO DISCONNECT THE MAINS PLUG IN CASE OF THE ACCIDENT. THE MAINS PLUG OF UNIT SHOULD BE UNPLUGGED FROM THE WALL SOCKET WHEN LEFT UNUSED FOR A LONG PERIOD OF TIME.

H017BE_n

Thank you for buying this Pioneer product. Please read through these operating instructions so you will know how to operate your model properly. After you have finished reading the instructions, put them away in a safe place for future reference.

IMPORTANT NOTICE

H006AE_n

The serial number for this equipment is located in the rear panel. Please write this serial number on your enclosed warranty card and keep it in a secure area. This is for your security.

NOTE: This equipment has been tested and found to comply with the limits for a Class B digital device, pursuant to Part 15 of the FCC Rules. These limits are designed to provide reasonable protection against harmful interference in a residential installation. This equipment generates, uses, and can radiate radio frequency energy and, if not installed and used in accordance with the instructions, may cause harmful interference to radio communications. However, there is no guarantee that interference will not occur in a particular installation. If this equipment does cause harmful interference to radio or television reception, which can be determined by turning the equipment off and on, the user is encouraged to try to correct the interference by one or more of the following measures:

- Reorient or relocate the receiving antenna.
- Increase the separation between the equipment and receiver.
- Connect the equipment into an outlet on a circuit different from that to which the receiver is connected.
- Consult the dealer or an experienced radio/TV technician for help.

H010 En

Information to User

Alteration or modifications carried out without appropriate authorization may invalidate the user's right to operate the equipment.

H011 En

CAUTION:

This product satisfies FCC regulations when shielded cables and connectors are used to connect the unit to other equipment. To prevent electromagnetic interference with electric appliances such as radios and televisions, use shielded cables and connectors for connections.

H012 En

WARNING: Handling the cord on this product or cords associated with accessories sold with the product will expose you to lead, a chemical known to the State of California and other governmental entities to cause cancer and birth defects or other reproductive harm. **Wash hands after handling.**

IMPORTANT



The lightning flash with arrowhead symbol, within an equilateral triangle, is intended to alert the user to the presence of uninsulated "dangerous voltage" within the product's enclosure that may be of sufficient magnitude to constitute a risk of electric shock to persons.

CAUTION
RISK OF ELECTRIC SHOCK
DO NOT OPEN

CAUTION:
TO PREVENT THE RISK OF ELECTRIC SHOCK, DO NOT REMOVE COVER (OR BACK). NO USER-SERVICEABLE PARTS INSIDE. REFER SERVICING TO QUALIFIED SERVICE PERSONNEL.



The exclamation point within an equilateral triangle is intended to alert the user to the presence of important operating and maintenance (servicing) instructions in the literature accompanying the appliance.

IMPORTANT SAFETY INSTRUCTIONS

H003 En

READ INSTRUCTIONS — All the safety and operating instructions should be read before the product is operated.

RETAIN INSTRUCTIONS — The safety and operating instructions should be retained for future reference.

HEED WARNINGS — All warnings on the product and in the operating instructions should be adhered to.

FOLLOW INSTRUCTIONS — All operating and use instructions should be followed.

CLEANING — Unplug this product from the wall outlet before cleaning. The product should be cleaned only with a polishing cloth or a soft dry cloth. Never clean with furniture wax, benzene, insecticides or other volatile liquids since they may corrode the cabinet.

ATTACHMENTS — Do not use attachments not recommended by the product manufacturer as they may cause hazards.

WATER AND MOISTURE — Do not use this product near water — for example, near a bathtub, wash bowl, kitchen sink, or laundry tub; in a wet basement; or near a swimming pool, and the like.

ACCESSORIES — Do not place this product on an unstable cart, stand, tripod, bracket, or table. The product may fall, causing serious injury to a child or adult, and serious damage to the product. Use only with a cart, stand, tripod, bracket, or table recommended by the manufacturer, or sold with the product. Any mounting of the product should follow the manufacturer's instructions, and should use a mounting accessory recommended by the manufacturer.

CART — A product and cart combination should be moved with care. Quick stops, excessive force, and uneven surfaces may cause the product and cart combination to overturn.



VENTILATION — Slots and openings in the cabinet are provided for ventilation and to ensure reliable operation of the product and to protect it from overheating, and these openings must not be blocked or covered. The openings should never be blocked by placing the product on a bed, sofa, rug, or other similar surface. This product should not be placed in a built-in installation such as a bookcase or rack unless proper ventilation is provided or the manufacturer's instructions have been adhered to.

POWER SOURCES — This product should be operated only from the type of power source indicated on the marking label. If you are not sure of the type of power supply to your home, consult your product dealer or local power company.

LOCATION — The appliance should be installed in a stable location.

NONUSE PERIODS — The power cord of the appliance should be unplugged from the outlet when left unused for a long period of time.

GROUNDING OR POLARIZATION

- If this product is equipped with a polarized alternating current line plug (a plug having one blade wider than the other), it will fit into the outlet only one way. This is a safety feature. If you are unable to insert the plug fully into the outlet, try reversing the plug. If the plug still will not fit, contact your electrician to replace your obsolete outlet. Do not defeat the safety purpose of the polarized plug.
- If this product is equipped with a three-wire grounding type plug, a plug having a third (grounding) pin, it will only fit into a grounding type power outlet. This is a safety feature. If you are unable to insert the plug into the outlet, contact your electrician to replace your obsolete outlet. Do not defeat the safety purpose of the grounding type plug.

POWER-CORD PROTECTION — Power-supply cords should be routed so that they are not likely to be walked on or pinched by items placed upon or against them, paying particular attention to cords at plugs, convenience receptacles, and the point where they exit from the product.

OUTDOOR ANTENNA GROUNDING — If an outside antenna or cable system is connected to the product, be sure the antenna or cable system is grounded so as to provide some protection against voltage surges and built-up static charges. Article 810 of the National Electrical Code, ANSI/NFPA 70, provides information with regard to proper grounding of the mast and supporting structure, grounding of the lead-in wire to an antenna discharge unit, size of grounding conductors, location of antenna-discharge unit, connection to grounding electrodes, and requirements for the grounding electrode. See Figure A.

LIGHTNING — For added protection for this product during lightning storm, or when it is left unattended and unused for long periods of time, unplug it from the wall outlet and disconnect the antenna or cable system. This will prevent damage to the product due to lightning and power-line surges.

POWER LINES — An outside antenna system should not be located in the vicinity of overhead power lines or other electric light or power circuits, or where it can fall into such power lines or circuits. When installing an outside antenna system, extreme care should be taken to keep from touching such power lines or circuits as contact with them might be fatal.

OVERLOADING — Do not overload wall outlets, extension cords, or integral convenience receptacles as this can result in a risk of fire or electric shock.

OBJECT AND LIQUID ENTRY — Never push objects of any kind into this product through openings as they may touch dangerous voltage points or short-out parts that could result in a fire or electric shock. Never spill liquid of any kind on the product.

SERVICING — Do not attempt to service this product yourself as opening or removing covers may expose you to dangerous voltage or other hazards. Refer all servicing to qualified service personnel.

DAMAGE REQUIRING SERVICE — Unplug this product from the wall outlet and refer servicing to qualified service personnel under the following conditions:

- When the power-supply cord or plug is damaged,
- If liquid has been spilled, or objects have fallen into the product,
- If the product has been exposed to rain or water,
- If the product does not operate normally by following the operating instructions. Adjust only those controls that are covered by the operating instructions as an improper adjustment of other controls may result in damage and will often require extensive work by a qualified technician to restore the product to its normal operation.
- If the product has been dropped or damaged in any way,
- When the product exhibits a distinct change in performance — this indicates a need for service.

REPLACEMENT PARTS — When replacement parts are required, be sure the service technician has used replacement parts specified by the manufacturer or have the same characteristics as the original part. Unauthorized substitutions may result in fire, electric shock, or other hazards.

SAFETY CHECK — Upon completion of any service or repairs to this product, ask the service technician to perform safety checks to determine that the product is in proper operating condition.

WALL OR CEILING MOUNTING — The product should not be mounted to a wall or ceiling.

HEAT — The product should be situated away from heat sources such as radiators, heat registers, stoves, or other products (including amplifiers) that produce heat.

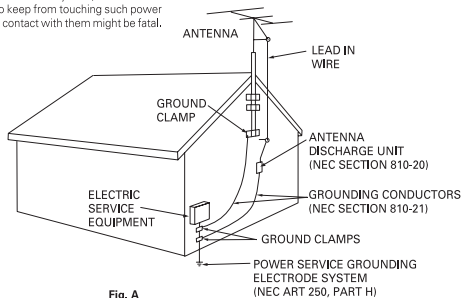

Fig. A

NEC — NATIONAL ELECTRICAL CODE

Manufactured under license from Dolby Laboratories. "Dolby", "Pro Logic" and the double-D symbol are trademarks of Dolby Laboratories.

"DTS", and "DTS Digital Surround" are registered trademarks of Digital Theater Systems, Inc.

Contents

1 Before you start

| | |
|--|---|
| Checking what's in the box | 6 |
| Installing the receiver | 6 |
| Making cable connections | 6 |
| Loading the batteries | 6 |
| Operating range of remote control unit | 7 |

2 5 minute guide

| | |
|------------------------------------|----|
| Introduction to home theater | 8 |
| Listening to Surround Sound | 9 |
| Using the Quick Setup | 12 |

3 Connecting up

| | |
|---|----|
| Audio/Video cords | 13 |
| S-video cables (VSX-D512 only) | 13 |
| Digital audio cords/Optical cables | 13 |
| Connecting digital components | 14 |
| Connecting audio components | 14 |
| Connecting DVD 5.1 channel components ... | 15 |
| Connecting video components | 15 |
| Connecting antennas | 16 |
| FM wire antenna | 16 |
| AM loop antenna | 17 |
| Antenna snap connectors | 17 |
| Using external antennas | 17 |
| To improve FM reception | 17 |
| To improve AM reception | 17 |
| Connecting the speakers | 18 |
| Speaker terminals | 18 |
| Hints on speaker placement | 19 |
| AC outlet | 20 |
| Operating other Pioneer components | 20 |

4 Controls and displays

| | |
|---------------------------------|----|
| Remote Control (VSX-D512) | 21 |
| Remote Control (VSX-D412) | 24 |
| Front Panel | 26 |
| Display | 28 |

5 Playing sources

| | |
|---|----|
| Introduction to Sound Modes | 30 |
| Stereo/Direct | 30 |
| Standard modes | 30 |
| Advanced Surround modes | 30 |
| Choosing the input signal | 31 |
| Using Stereo/Direct | 31 |
| Listening to multi-channel playback | 32 |
| Using Advanced Surround | 32 |
| Using Loudness and Midnight listening | 32 |
| Using the tone controls | 33 |
| Playing other sources | 33 |
| Selecting the multi-channel analog inputs ... | 34 |

6 Setting up the receiver

| | |
|--|----|
| Choosing your receiver setup | 35 |
| Speaker setting | 36 |
| Subwoofer setting | 36 |
| Crossover frequency setting | 36 |
| LFE attenuator setting | 37 |
| Front speaker distance setting | 37 |
| Center speaker distance setting | 37 |
| Surround speaker distance setting | 37 |
| Dynamic range control setting | 38 |
| Dual mono setting | 38 |
| Coaxial digital input setting | 38 |
| Optical digital input setting | 38 |
| Setting the relative volume level of each channel | 39 |

7 Using the tuner

| | |
|---|----|
| Listening to the radio | 40 |
| Tuning directly to a station (VSX-D512 only) | 41 |
| Improving FM stereo sound | 41 |
| Saving station presets | 42 |
| Naming station presets | 43 |
| Listening to station presets | 43 |

8 Making recordings

| | |
|--|----|
| Making an audio or a video recording | 44 |
| Monitoring your recording | 44 |

9 Controlling the rest of your system

| | |
|---|----|
| Setting the remote to control other components (VSX-D512 only) | 45 |
| Selecting preset codes (VSX-D512 only) | 45 |
| Direct function (VSX-D512 only) | 46 |
| Clearing the Preset Codes (VSX-D512 only) | 47 |
| Controls for TVs (VSX-D512 only) | 48 |
| Controls for other components (VSX-D512 only) | 49 |
| Preset Code List (VSX-D512 only) | 51 |

10 Additional information

| | |
|-----------------------|----|
| Troubleshooting | 53 |
| Specifications | 55 |

Checking what's in the box

Please check that you've received the following supplied accessories:

- AM loop antenna
- FM wire antenna
- Dry cell batteries (AA size IEC R6) × 2
- Remote control
- These operating instructions

Installing the receiver

Please note the following points:

- Do not place objects directly on top of this unit. This would prevent proper heat dispersal.

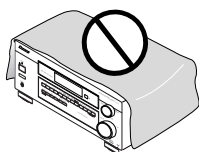

- When installing on a rack, shelf, etc., be sure to leave more than 8 inches (20 cm.) of space above the receiver.

Making cable connections

Make sure not to bend the cables over the top of this unit (as shown in the illustration). If this happens, the magnetic field produced by the transformers in this unit may cause a humming noise from the speakers.

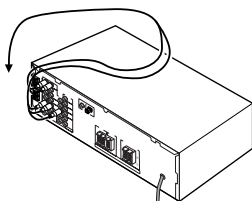

Loading the batteries

VSX-D412

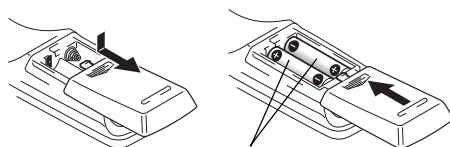

Dry cell batteries
(AA size IEC R6) × 2

VSX-D512

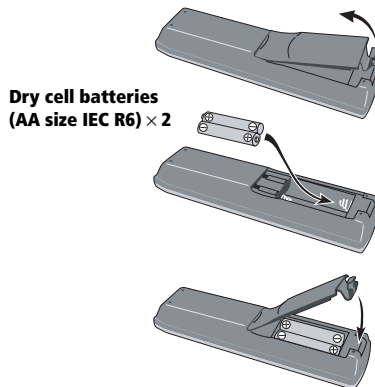

Dry cell batteries
(AA size IEC R6) × 2



Caution

Incorrect use of batteries may result in such hazards as leakage and bursting. Observe the following precautions:

- Never use new and old batteries together.
- Insert the plus and minus sides of the batteries properly according to the marks in the battery case.
- Batteries with the same shape may have different voltages. Do not use different batteries together.
- When disposing of used batteries, please comply with governmental regulations or environmental public instruction's rules that apply in your country or area.

Operating range of remote control unit

The remote control may not work properly if:

- There are obstacles between the remote control and the receiver's remote sensor.
- Direct sunlight or fluorescent light is shining onto the remote sensor.
- The receiver is located near a device that is emitting infrared rays.
- The receiver is operated simultaneously with another infrared remote control unit.

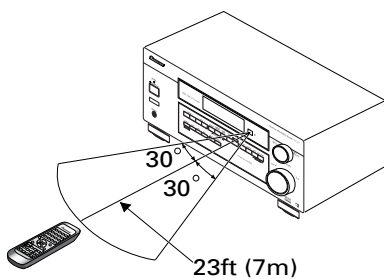

Introduction to home theater

You are probably used to using stereo equipment to listen to music, but may not be used to home theater systems that give you many more options (such as surround sound) when listening to soundtracks.

Home theater refers to the use of multiple audio tracks to create a surround sound effect, making you feel like you're in the middle of the action or concert. The surround sound you get from a home theater system depends not only on the speakers you have set up in your room, but also on the source and the sound settings of the receiver.

DVD-Video has become the basic source material for home theater due to its size, quality, and ease of use. Depending on the DVD, you can have up to seven different audio tracks coming from one disc, all of them being sent to different speakers in your system. This is what creates a surround sound effect and gives you the feeling of 'being there'.

This receiver will automatically decode Dolby Digital, DTS, or Dolby Surround DVD-Video discs, according to your speaker setup. In most cases, you won't have to make changes for realistic surround sound, but other possibilities (like listening to a CD with multi-channel surround sound) are explained in *Playing sources*, starting on page 30.

Listening to Surround Sound

This receiver was designed with the easiest possible setup in mind, so with the following quick setup guide, you should have your system hooked up for surround sound in no time at all. In most cases, you can simply leave the receiver in the default settings.

1 Hook up your DVD player.

For surround sound, you'll want to hook up using a digital connection from the DVD player to the receiver. You can do this with either a coaxial, or an optical connection (you don't need to do both). If you hook up using an optical cable, you should refer to *Optical digital input setting* on page 38 to assign the optical input to DVD.

Use a video cord to connect the video output on your DVD to the receiver using the jacks shown below.

2 Hook up your TV.

Use a video cord to connect your receiver to the TV using the jacks as shown below.

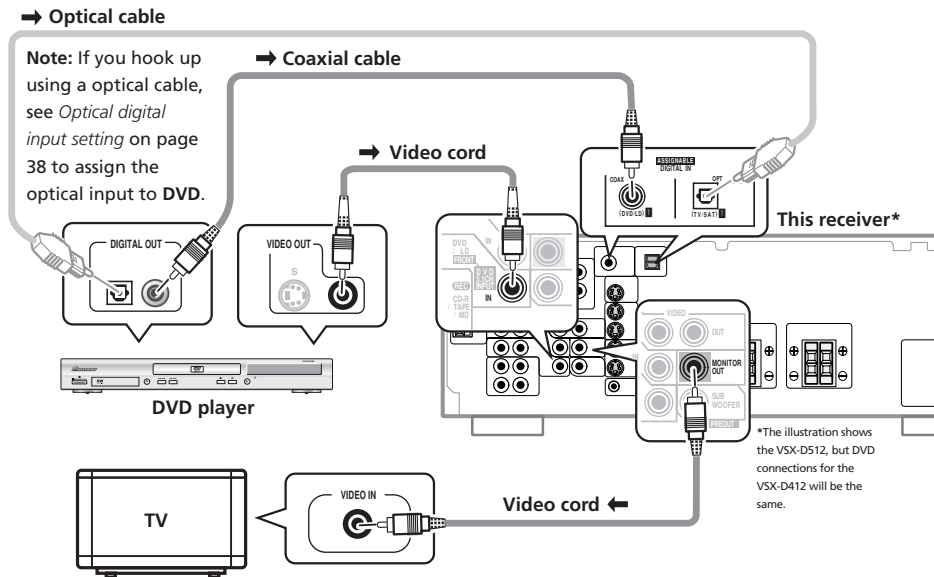

3 Connect your speakers.

A complete setup of six speakers (including the subwoofer) is shown here, but everyone's home setup will vary. Simply connect the speakers you have in the manner shown below. The receiver will work with just two stereo speakers (the front speakers in the diagram) but using at least three speakers is recommended, and all six is best. If you're not using a subwoofer, change the front speaker setting (see *Speaker setting* on page 36) to large.

Make sure you connect the speaker on the right to the right terminal and the speaker on the left to the left terminal. Also make sure the positive and negative (+/-) terminals on the receiver match those on the speakers.



Note

Use speakers with a nominal impedance of 8 Ω to 16 Ω .

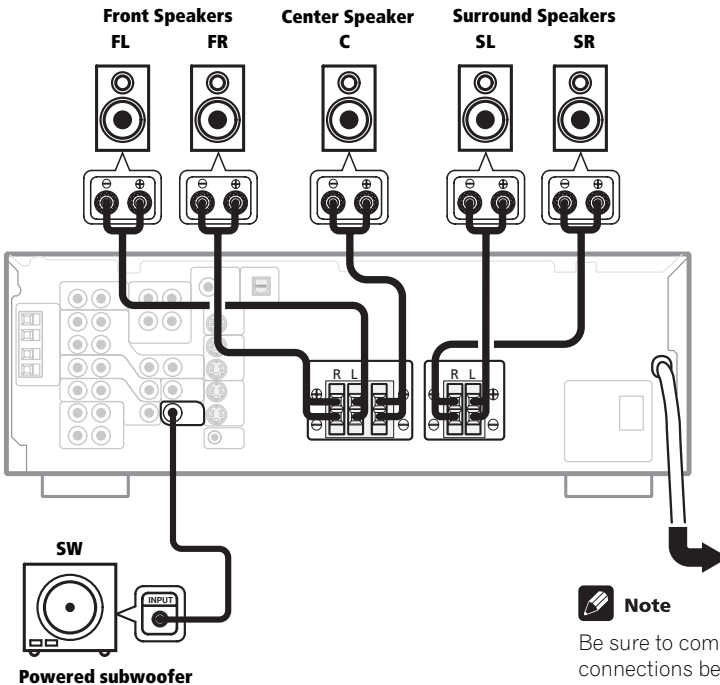

Note

Be sure to complete all connections before connecting this unit to the AC power source.

4 Plug in the receiver and switch it on, followed by your DVD player, your subwoofer and the TV.

Make sure you've set the video input on your TV to this receiver. Check the manual that came with the TV if you don't know how to do this.

Also make sure that **DVD/LD** is showing in the receiver's display, indicating that the DVD input is selected. If it isn't, press **DVD/LD** on the remote control to set the receiver to the DVD input.

5 Press QUICK SETUP on the front panel to specify your speaker setup and your room size.

Use the **MULTI JOG/INPUT SELECTOR** dial to select and **ENTER** to confirm your selection. See *Using the Quick Setup* on the next page if you're unsure about the settings.

6 Play a DVD, and adjust the volume to your liking.

There are several other sound options you can select. See pages 30 to 33 for more on this. See also *Choosing your receiver setup* on pages 35 to 39 for more setup options.

**Note**

Depending on your DVD player or source discs, you may only get digital 2 channel stereo and analog sound. In this case, the listening mode must be set to Standard (it should already be set—see page 32 if you need to do this) if you want multi-channel surround sound.

Using the Quick Setup

You can use the Quick Setup to get your system up and running with just a few button presses. The receiver automatically makes the necessary settings after you have selected your speaker setup and room size. If you want to make more specific settings, refer to *Choosing your receiver setup* on pages 35 to 39. Use the front panel controls for the steps below.

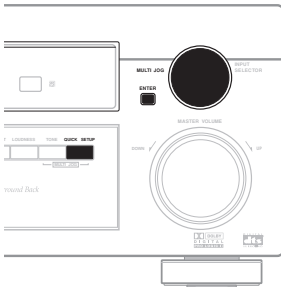

- 1 Press **POWER** to turn the power on. The **STANDBY** indicator goes out.
- 2 Press **QUICK SETUP**. The display prompts you to select your speaker setup.
- 3 Use the **MULTI JOG/INPUT SELECTOR dial** to choose your speaker setup. Cycle between the following choices:

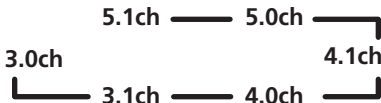

Note

Check the table below to find the speaker setup that corresponds with your system.

| | Front Speakers | Center Speaker | Surround Speakers | Sub Woofer |
|---------------|----------------|----------------|-------------------|------------|
| 3.0 ch | √ | √ | | |
| 3.1 ch | √ | √ | | √ |
| 4.0 ch | √ | | √ | |
| 4.1 ch | √ | | √ | √ |
| 5.0 ch | √ | √ | √ | |
| 5.1 ch | √ | √ | √ | √ |

4 Press ENTER.

The display prompts you to select your room size.

5 Use the MULTI JOG/INPUT SELECTOR dial to choose your room size.

Depending on the distance of your surround speakers, choose between **S**mall, **M**edium, or **L**arge (see table below).

| | S | M | L |
|-----------------|--------|--------|--------|
| Front | 12 ft. | 12 ft. | 12 ft. |
| Center | 10 ft. | 10 ft. | 10 ft. |
| Surround | 6 ft. | 7 ft. | 9 ft. |

6 Press ENTER to confirm your setup.

The display shows the speaker setup and room size that you have selected.

Before making or changing the connections, switch off the power and disconnect the power cord from the AC outlet.

Audio/Video cords

Use audio/video cords (not supplied) to connect the audio/video components and a video cord to connect the monitor TV.

Connect red plugs to **R** (right), white plugs to **L** (left), and the yellow plugs to **VIDEO**.

Be sure to insert completely.

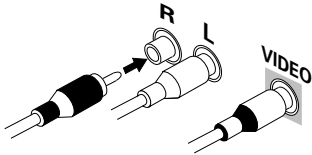

Digital audio cords/Optical cables

Commercially available digital audio coaxial cords (standard video cords can also be used) or optical cables (not supplied) are used to connect digital components to this receiver.

Be sure to insert completely.

Digital audio coaxial cord (or standard video cord)

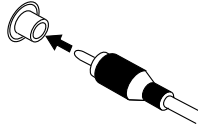

Optical cable

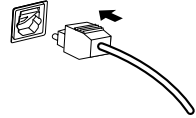

S-video cables (VSX-D512 only)

Use S-video cables (not supplied) to get clearer picture reproduction than regular video cords.

Connect from an S-video jack on the rear of the receiver to an S-video jack on the video component you are hooking up.

Be sure to insert completely.

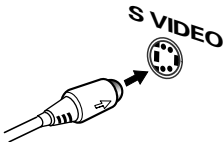

Connecting digital components

For proper decoding of Dolby Digital/DTS soundtracks, you need to make digital audio connections. You can do this by either coaxial or optical connections (you don't need to do both). The quality of these two types of connections is the same, but since some digital components only have one type of digital terminal, it is a matter of matching like with like (for example, the coaxial output from the component to the coaxial input on the receiver). This receiver has both a coaxial and an optical input for a total of two digital inputs. Connect your digital components as shown below.

When connecting your equipment, always make sure the power is turned off and the power cord is disconnected from the wall outlet.

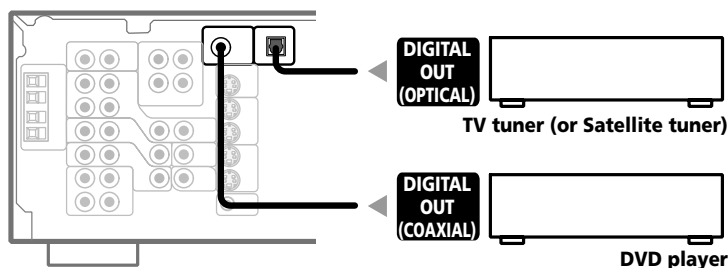

Note

The arrows indicate the direction of the audio signal.

Connecting audio components

To begin set up, connect your analog audio components (such as a cassette deck) to the jacks. For components you want to record with, you need to hook up four plugs (a set of stereo ins and a set of stereo outs), but for components that only play, you only need to hook up one set of stereo ins (two plugs). You should also hook up your digital components to analog audio jacks if you want to record to/from digital components (like an MD) to/from analog components. See above for more on digital connections.

When connecting your equipment, always make sure the power is turned off and the power cord is disconnected from the wall outlet.

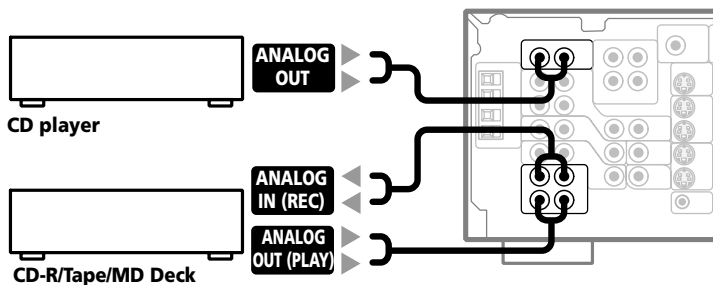

Note

The arrows indicate the direction of the audio signal.

Connecting DVD 5.1 channel components

If you prefer to use a separate component for decoding DVDs, you can connect a decoder or a DVD player with multi-channel analog outputs to the multi-channel inputs of this receiver.

When connecting your equipment, always make sure the power is turned off and the power cord is disconnected from the wall outlet.

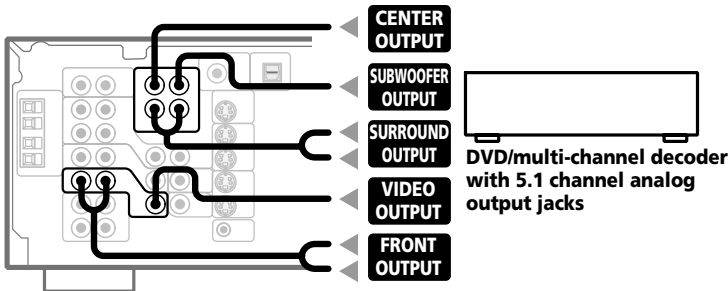

Note
The arrows indicate the direction of the signal.

Note

The 5.1 channel input can only be used when **DVD 5.1 ch** is selected (see page 34).

Connecting video components

Connect your video components to the jacks as shown below. Regarding digital video components (like a DVD player), you must use the connections pictured on this page for the video signal, but in order to hear a digital source (like a DVD) you should hook up the audio to a digital input (see page 14). It is also a good idea to hook up your digital components with analog audio connections (see page 14).

For better quality video, you can hook up using the S-video jacks on the rear of the receiver instead of the regular video jacks (VSX-D512 only). Make sure you use an S-video cable to connect to the S-video jack on the component you are hooking up (see page 13).

When connecting your equipment always make sure the power is turned off and the power cord is disconnected from the wall outlet.

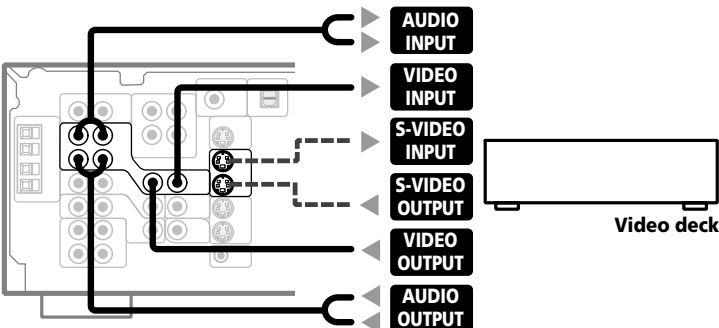

Note
The arrows indicate the direction of the signal.

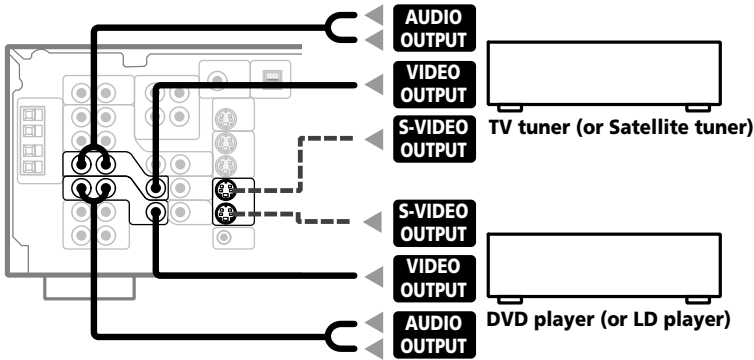
**Note**

The arrows indicate the direction of the signal.

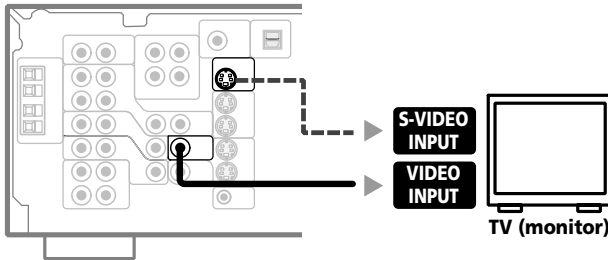
**Note**

The arrows indicate the direction of the signal.

Connecting antennas

Connect the AM loop antenna and the FM wire antenna as shown at right. To improve reception and sound quality, connect external antennas (see *Using external antennas*, next page). Always make sure that the receiver is switched off and unplugged from the wall outlet before making or changing any connections.

FM wire antenna

Connect the FM wire antenna and fully extend vertically along a window frame or other suitable area, etc.

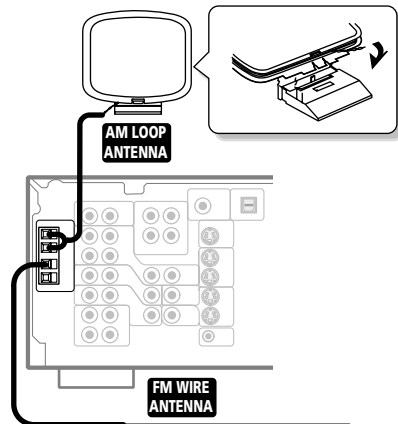

AM loop antenna

Assemble the antenna and connect to the receiver. Attach to a wall, etc. (if desired) and face in the direction that gives the best reception.

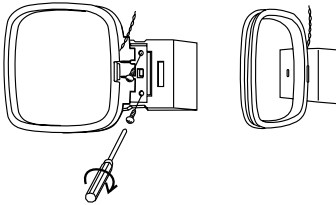

Antenna snap connectors

Twist the exposed wire strands together and insert into the hole, then snap the connector shut.

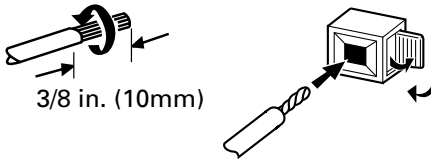

Using external antennas

To improve FM reception

Connect an external FM antenna.

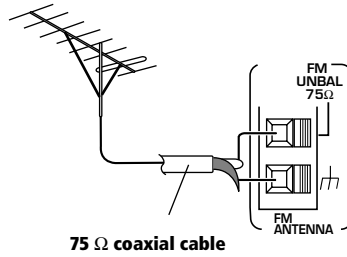

To improve AM reception

Connect a 15-18 feet length of vinyl-coated wire to the AM antenna terminal without disconnecting the supplied AM loop antenna.

For the best possible reception, suspend horizontally outdoors.

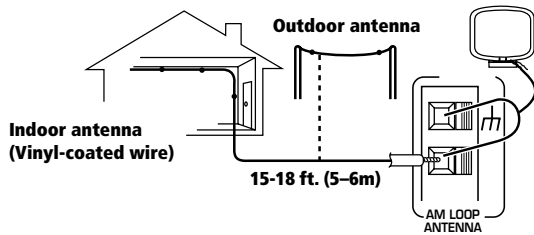

Connecting the speakers

A complete setup of six speakers (including the subwoofer) is shown here, but everyone's home setup will vary. Simply connect the speakers you have in the manner shown below. The receiver will work with just two stereo speakers (the front speakers in the diagram) but using at least three speakers is recommended, and a complete setup is best for surround sound. If you're not using a subwoofer, change the front speaker setting (see *Speaker setting* on page 36) to large.

Make sure you connect the speaker on the right to the right terminal and the speaker on the left to the left terminal. Also make sure the positive and negative (+/-) terminals on the receiver match those on the speakers.

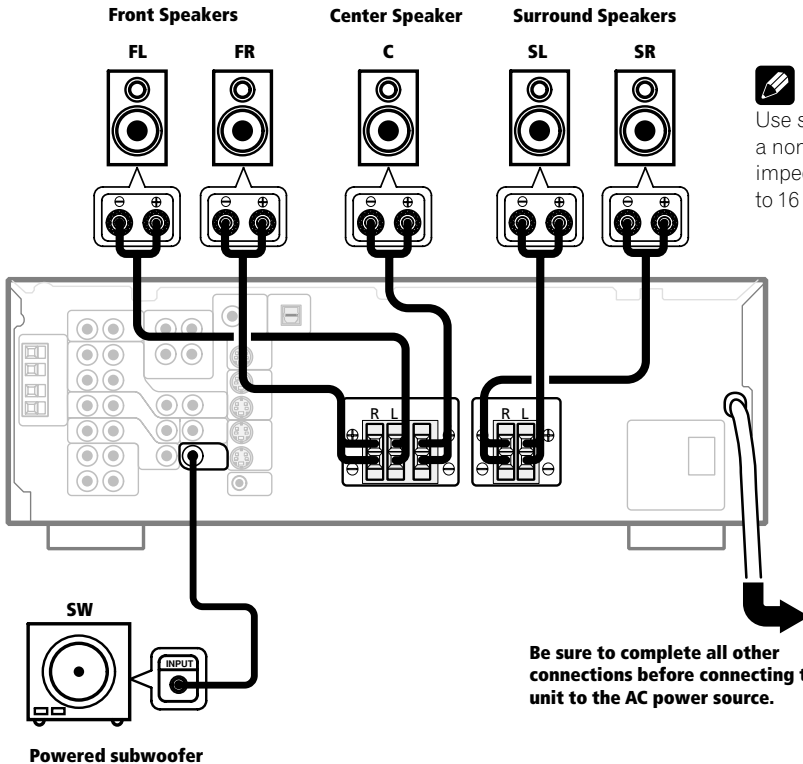

Speaker terminals

- 1 Twist around 1/2 inch of bare wire strands together.
- 2 Unclip the speaker terminal and insert the wire.
- 3 Snap shut the speaker terminal to secure.

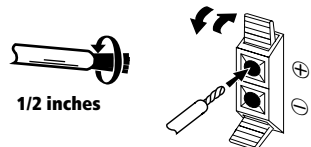



Caution

Make sure that all the bare speaker wire is twisted together and inserted fully into the speaker terminal. If any of the bare speaker wire touches the rear panel it may cause the power to cut off as a safety measure. Use good quality speaker wire to connect the speakers to the receiver.

Hints on speaker placement

Speakers are usually designed with a particular placement in mind. Some are designed to be floorstanding, while others should be placed on stands to sound their best. Some should be placed near a wall; others should be placed away from walls. We have provided a few tips on getting the best sound from your speakers (below), but you should also follow the guidelines on placement that the speaker manufacturer provided with your particular speakers to get the most out of them.

- Place the front left and right speakers at equal distances from the TV.
- When placing speakers near the TV, we recommend using magnetically shielded speakers to prevent possible interference, such as discoloration of the picture when the TV is switched on. If you do not have magnetically shielded speakers and notice discoloration of the TV picture, move the speakers farther away from the TV.
- Place the center speaker above or below the TV so that the sound of the center channel is localized at the TV screen.
- To achieve the best possible surround sound, install your speakers as shown below. Be sure all speakers are installed securely to prevent accidents and improve sound quality.

Overhead view of speaker set up

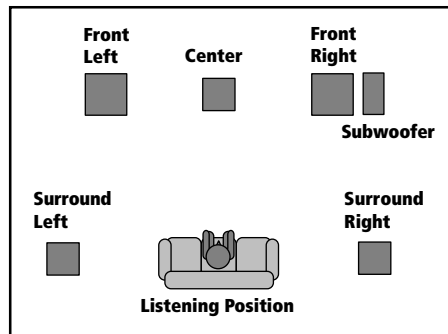

Caution

If you choose to install the center speaker on top of the TV, be sure to secure it with putty, or by other suitable means, to reduce the risk of damage or injury resulting from the speaker falling from the TV in the event of external shocks such as earthquakes.

- If possible, place the surround speakers slightly above ear level.
- Try not to place the surround speakers further away from the listening position than the front and center speakers. Doing so can weaken the surround sound effect.

3-D view of speaker set up

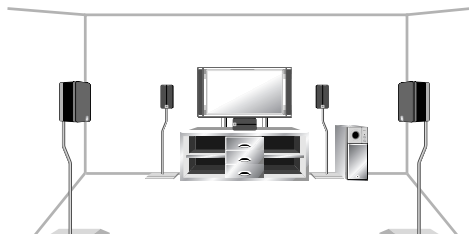

AC outlet

[switched 100 W (0.8 A) max]

Power supplied through this outlet is turned on and off by the receiver's power switch. Total electrical power consumption of connected equipment should not exceed 100 W (0.8 A).



Caution

DO NOT CONNECT A MONITOR, TV SET, HEATER, OR SIMILAR APPLIANCE TO THIS UNIT'S AC OUTLET.

Do not connect appliances with high power consumption to the **AC OUTLET** in order to avoid overheating and fire risk. This can also cause the receiver to malfunction.

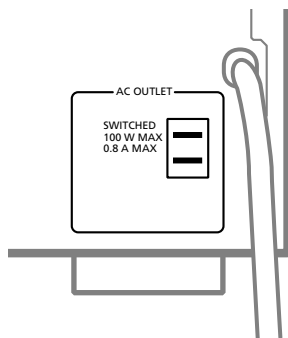

Note

- Make sure no exposed speaker wire is touching the rear panel, this may cause the receiver to turn off automatically.
- This unit should be disconnected by removing the power plug from the wall socket when not in regular use (ex. when on vacation).

POWER-CORD CAUTION

Handle the power cord by the plug. Do not pull out the plug by tugging the cord and never touch the power cord when your hands are wet as this could cause a short circuit or an electric shock. Do not place the unit, a piece of furniture, etc., on the power cord, or pinch the cord. Never make a knot in the cord or tie it with other cords. The power cords should be routed such that they are not likely to be stepped on. A damaged power cord can cause a fire or give you an electrical shock. Check the power cord once in a while. When you find it damaged, ask your nearest Pioneer authorized service center or your dealer for a replacement.

Operating other Pioneer components

By connecting a control cord (optional), you can point the remote controls of other Pioneer components at the receiver's remote sensor. You can also use the remote control from this unit to control a Pioneer DVD player. The remote control signals are received by the remote sensor of this unit, and sent to the other devices via the **CONTROL OUT** terminal.

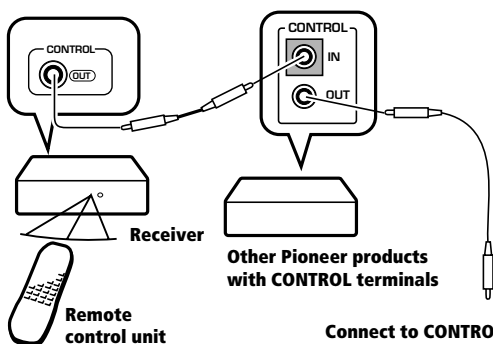

Connect to CONTROL IN terminal of other Pioneer products with CONTROL terminals

Remote Control (VSX-D512)

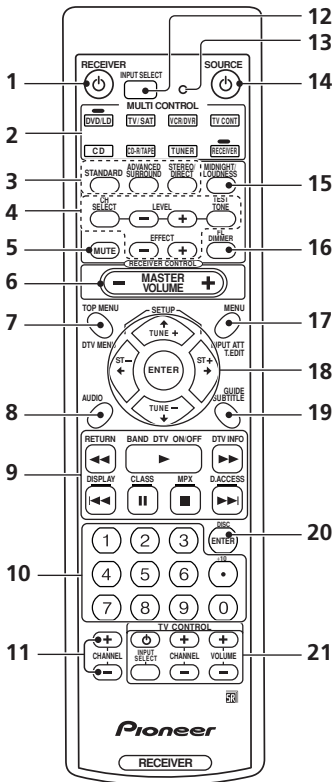

1 RECEIVER

Switches the receiver between on and standby.

2 MULTI CONTROL buttons

Use to select the input source.

3 LISTENING MODE buttons

STANDARD (page 30, 32, 39)

Press for Standard decoding and to switch between the various Pro Logic II options.

ADVANCED SURROUND (page 30, 32)

Use to switch between the various surround modes.

STEREO/DIRECT (pages 30–31)

Switches direct playback on or off. Direct playback bypasses the tone controls and channel levels for the most accurate reproduction of a source.

4 CH SELECT (page 39)

Use to select a channel when setting up the surround sound of the receiver.

TEST TONE (page 39)

Use to sound the test tones when setting up the surround sound of the receiver.

LEVEL +/- (page 39)

Use to set up the levels of the surround sound of the receiver.

EFFECT +/- (page 32)

Use to add or subtract the amount of effect in the Movie, Music and Expanded Advanced Surround modes.

5 MUTE

Use to mute the sound or restore the sound if it has been muted.

6 MASTER VOLUME

Use to set the overall listening volume.

7 TOP MENU

Use to return to the most basic menu on a DVD player or disc.

DTV MENU

Use to display the menus on a digital TV tuner.

8 AUDIO

Use to switch the audio tracks of a DVD when in DVD mode.

9 Component/Tuner controls

The main buttons (▶, ■, etc.) are used to control a component after you have selected it using the MULTI CONTROL buttons. The tuner/DTV controls above these buttons can be accessed after you have selected the corresponding MULTI CONTROL button (TUNER or TV/SAT (when connected to DTV)).

RETURN

Returns to the last screen selected when using a digital TV tuner.

BAND DTV ON/OFF

Use to switch between the AM and FM bands when the tuner is selected. Also switches a digital TV on/off.

DTV INFO

You can access the DTV information with this button.

DISPLAY (page 43)

Use to switch the display between the station preset name and the frequency.

CLASS (pages 42–43)

Use to switch between the three banks (classes) of station presets.

MPX (page 41)

Use to switch between auto stereo and mono reception of FM broadcasts. If the signal is weak then switching to mono will improve the sound quality.

D. ACCESS (page 41)

After pressing, you can access a radio station directly using the number buttons.

10 Number buttons

Use to enter track numbers on discs or radio frequencies.

11 CHANNEL +/- buttons

Use to select channels on other components such as a DVR or satellite tuner.

12 INPUT SELECT

Use to select the input source.

13 LED indicator

This indicator flashes when a command is sent from the remote control to the receiver. It also flashes when teaching the receiver preset codes.

14 SOURCE

Use this button to turn on or off the power of other components.

15 MIDNIGHT/LOUDNESS (page 32)

Use to switch to Midnight or Loudness listening.

16 FL DIMMER

Use this button to make the fluorescent display (FL) dimmer or brighter.

17 MENU

Use to access different menus associated with your DVD player.

INPUT ATT

Use to attenuate (lower) the level of an analog input signal to prevent distortion.

T. EDIT (pages 42–43)

Press to memorize and name a station for recall using the **STATION (+/-)** buttons.

18 (TUNE +/-, ST +/-) & ENTER buttons

Use the arrow buttons when setting up your surround sound system (see page 35). Also used to control DVD menus/options and for deck 1 of a double cassette deck player. Use the **TUNE +/-** buttons to find radio frequencies and use **ST +/-** to find preset stations (page 40–43).

19 GUIDE

Use to display the guides on a digital TV.

SUBTITLE

Displays/changes the subtitles included in multilingual DVD-Video discs.

20 ENTER (page 48–50)

It can be used to enter commands for TV, CATV and TUNER.

21 TV CONTROL buttons:

These controls are for your TV. They are dedicated TV controls and will work no matter what mode the remote control is in. They can, however, be set for different TVs. By default they will control the TV. Thus if you only have one TV, assign it to the TV/SAT button (see page 45).

Remote Control (VSX-D412)

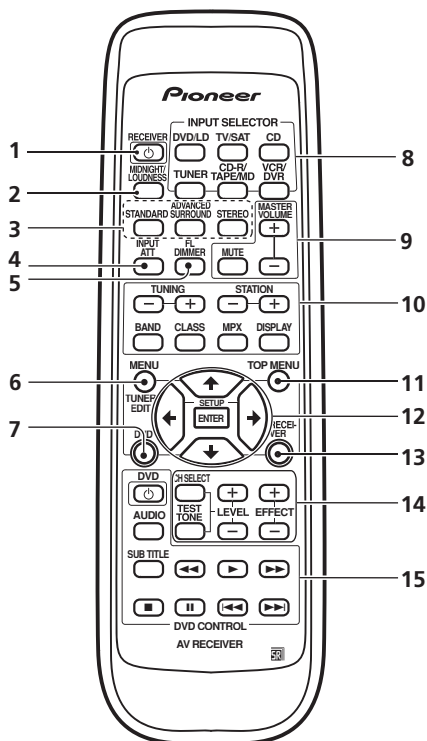

1 RECEIVER

Switches the receiver between on and standby.

2 **MIDNIGHT/LOUDNESS** (page 32)

Use to switch to Midnight or Loudness listening.

3 **LISTENING MODE** buttons

STANDARD (page 30, 32, 39)

Press for Standard decoding and to switch between the various Pro Logic II options.

ADVANCED SURROUND (page 30, 32)

Use to switch between the various surround modes.

STEREO (pages 30–31)

Switches direct playback on or off. Direct playback bypasses the tone controls and channel levels for the most accurate reproduction of a source.

4 **INPUT ATT**

Use to attenuate (lower) the level of an analog input signal to prevent distortion.

5 **FL DIMMER**

Use this button to make the fluorescent display (FL) dimmer or brighter.

6 **MENU (DVD control)**

Use to access different menus associated with your DVD player.

TUNER EDIT (Receiver control) (pages 42–43)

Press to memorize and name a station for recall using the **STATION (+/-)** buttons.

7 **DVD**

Use to switch over to the DVD controls on the remote control.

Note

The DVD controls on the remote control (**TOP MENU**, **MENU**, $\leftarrow \rightarrow$ $\uparrow \downarrow$ and **ENTER/SETUP** buttons) can only be used for DVD control after pressing **DVD/LD** on the remote. See the next page for more on the separate **DVD CONTROL** buttons.

8 **INPUT SELECTOR** buttons

Use to select the input source.

9 **Volume** buttons

Use **MASTER VOLUME +/-** to set the overall listening volume. Use **MUTE** to mute the sound or restore the sound if it has been muted.

10 Tuner controls

The **TUNING +/-** buttons can be used to find radio frequencies. The **STATION +/-** buttons can be used to select preset radio stations (pages 42–43).

BAND (page 41)

Use to switch between the AM and FM bands when the tuner is selected.

CLASS (pages 42–43)

Use to switch between the three banks (classes) of station presets.

MPX (page 41)

Use to switch between auto stereo and mono reception of FM broadcasts. If the signal is weak then switching to mono will improve the sound quality.

DISPLAY (page 43)

Use to switch the display between the station preset name and the frequency.

11 TOP MENU

Displays the disc 'top' menu of a DVD.

12 and **ENTER/SETUP** buttons

Use these arrow buttons when setting up your surround sound system. These buttons are also used to control DVD menus/options.

13 RECEIVER

Use to switch to the receiver controls on the remote control. Also used when setting up the surround sound for the receiver.

14 **CH SELECT** (page 39)

Use to select a channel when setting up the surround sound of the receiver.

TEST TONE (page 39)

Use to sound the test tones when setting up the surround sound of the receiver.

LEVEL +/- (page 39)









Use to set up the levels of the surround sound of the receiver.

EFFECT +/- (page 32)

Use to add or subtract the amount of effect in the Movie, Music and Expanded Advanced Surround modes.

15 DVD CONTROL buttons

You can use these buttons to control a Pioneer DVD player connected to your system.

| Button | What it does |
|--|---|
| DVD  | Turns DVD power on/off. |
| AUDIO | Changes the audio language or channel. |
| SUBTITLE | Displays/changes the subtitles included in multilingual DVD-Video discs. |
|  | Press to start fast reverse scanning. |
|  | Starts playback. |
|  | Press to start fast forward scanning. |
|  | Stops playback. |
|  | Pauses a disc that's playing, or restarts a paused disc. |
|  | Skips to the start of the current track or chapter, then to previous tracks/chapters. |
|  | Skips to the next track or chapter. |

Front Panel

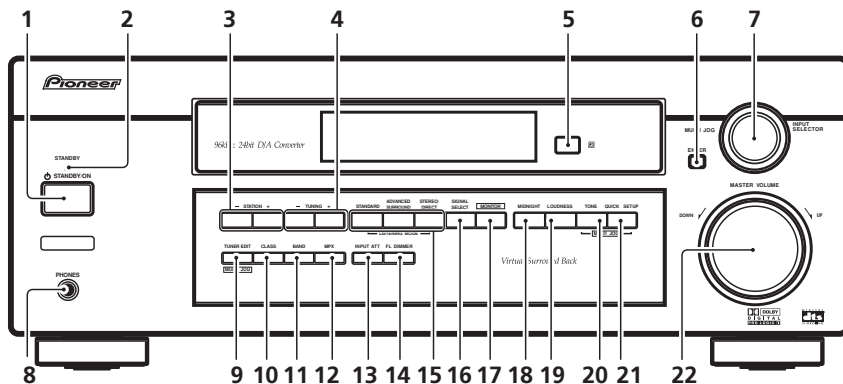

- 1** **STANDBY/ON**
Switches the receiver between on and standby.
- 2** **STANDBY indicator**
Lights when the receiver is in standby mode.
- 3** **STATION (+/-) buttons** (pages 42–43)
Selects station presets when using the tuner.
- 4** **TUNING (+/-) buttons** (page 40)
Selects the frequency when using the tuner.
- 5** **Remote sensor**
Receives the signals from the remote control.
- 6** **ENTER**
- 7** **MULTI JOG/INPUT SELECTOR dial**
The **MULTI JOG/INPUT SELECTOR** dial performs a number of tasks. Use it to select options after pressing **TONE**, **QUICK SETUP** or **TUNER EDIT**.
- 8** **PHONES jack**
Use to connect headphones.
- 9** **TUNER EDIT** (pages 42–43)
Press to memorize and name a station for recall using the **STATION (+/-)** buttons.
- 10** **CLASS** (pages 42–43)
Switches between the three banks (classes) of station presets.
- 11** **BAND** (page 40–41)
Switches between AM and FM radio bands.
- 12** **MPX** (page 41)
Press the **MPX** button to receive a radio broadcast in mono.
- 13** **INPUT ATT**
Use to attenuate (lower) the level of an analog input signal to prevent distortion.
- 14** **FL DIMMER**
Use this button to make the fluorescent display (FL) dimmer or brighter.
- 15** **LISTENING MODE buttons**
STANDARD (pages 30, 32, 39)
Press for Standard decoding and to switch between the various Pro Logic II options.



Note

When the headphones are connected, there is no sound output from the speakers.

ADVANCED SURROUND (pages 30, 32)

Use to switch between the various surround modes.

STEREO/DIRECT (pages 30–31)

Switches direct playback on or off. Direct playback bypasses the tone controls and channel levels for the most accurate reproduction of a source.

16 SIGNAL SELECT (page 31, 34)

Use to select between an analog or digital signal.

17 MONITOR (page 44)

Press to switch tape monitoring on/off.

18 MIDNIGHT (page 32)

Use when listening to movie soundtracks at low volumes.

19 LOUDNESS (page 32)

Use to boost the bass and treble at low volumes.

20 TONE (page 33)

Press this button to access the bass and treble controls, which you can then adjust with the **MULTI JOG/INPUT SELECTOR** dial.

21 QUICK SETUP (page 12)

22 MASTER VOLUME

Display

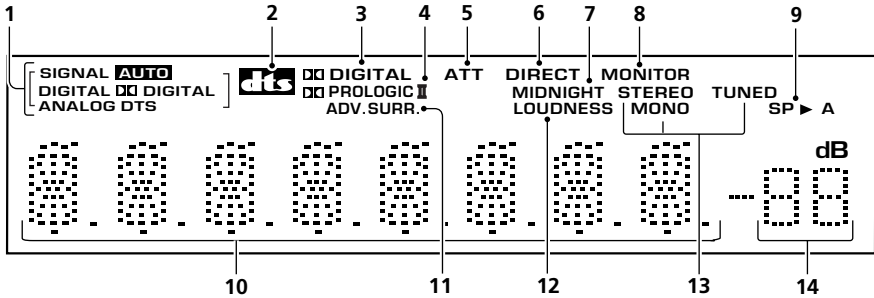

1 SIGNAL SELECT indicators

Lights to indicate the type of input signal assigned for the current component:

AUTO : Lights when AUTO signal select is on.

DIGITAL : Lights when a digital audio signal is detected.

DIGITAL : Lights when a Dolby Digital signal is detected.

ANALOG : Lights when an analog signal is detected.

DTS : Lights when a source with DTS audio signal is detected.

2 DTS

When the Standard mode of the receiver is on, this lights to indicate decoding of a DTS signal.

3 DIGITAL

When the Standard mode of the receiver is on, this lights to indicate decoding of a Dolby Digital signal.

4 PRO LOGIC II

When the Standard mode of the receiver is on, this lights to indicate Prologic II decoding.

5 ATT

Lights when **INPUT ATT** is used to attenuate (reduce) the level of the input signal (can only be used with an analog signal).

6 DIRECT

Lights when source direct playback is in use. Direct playback bypasses the tone controls and channel levels for the most accurate reproduction of a source.

7 MIDNIGHT

Lights during Midnight listening.

8 MONITOR

Lights when **MONITOR** is selected.

9 Speaker indicator

Shows if the speaker system is on or not.

SP ► A means speakers are switched on. **SP ►** means the headphones are connected.

10 Character display

11 ADV. Surr. (Advanced Surround)

Lights when one of the Advanced Surround listening modes of the receiver is selected.

12 LOUDNESS

Lights during Loudness listening.

13 TUNER indicators

STEREO : Lights when a stereo FM broadcast is being received in auto stereo mode.

MONO : Lights when the mono mode is set using the **MPX** button.

TUNED : Lights when a broadcast is being received.

14 Master volume level

Shows the overall volume level. **---** **dB** indicates the minimum level, and **- 0dB** indicates the maximum level.



Note

Depending on the level settings you make for each channel, the maximum level can range between **-10dB** and **- 0dB**.

Introduction to Sound Modes

There are three basic sound options: Stereo/Direct, Standard or Advanced Surround.

Stereo/Direct



When you select **STEREO** or **DIRECT**, you will hear the source through just the front left and right speakers (and possibly your subwoofer depending on your speaker settings). Dolby Digital and DTS multi-channel sources are downmixed to stereo.

In **STEREO**, the audio plays according to the surround setup settings and you can still use Midnight mode, Loudness mode and Tone Control functions.

When you select **DIRECT**, the audio bypasses the tone controls and channel levels for the most accurate reproduction of a source.

Standard modes

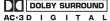
The Standard mode can be used to decode Dolby Digital, DTS or Dolby Surround sources. The surround mode options (below) can also add surround sound to regular stereo sources.

You can identify Dolby Digital software by the  or  marks. Most Dolby Surround software is marked , but unmarked software may also incorporate Dolby Surround.

Choose one of the following to add depth to a 2 channel source:

Pro Logic

This mode gives 4.1 channel surround sound. It is less sensitive to the quality of the source material, so may be useful when Pro Logic II Movie/ Music modes do not give good results.

Pro Logic II Movie

This mode gives 5.1 channel surround sound. It is suitable for movies, especially those recorded in Dolby Surround. The channel separation and movement of surround effects is comparable to Dolby Digital 5.1.

Pro Logic II Music

This mode gives 5.1 channel surround sound and is suitable for music. Compared to Pro Logic II Movie, the surround effect is more enveloping.

Advanced Surround modes

These are designed to be used with multi channel surround sound audio/visual sources (like DVDs and LDs). Most Advanced Surround modes are designed to be used with film soundtracks, but some modes are also suited for music sources. Try different settings with various soundtracks to see which you like.

Movie

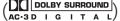
Simulates the relaxed environment of a movie theater, and is suitable for watching movies on sources marked   or .

Music

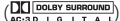
Simulates the acoustic environment of a large concert hall and is suitable for music or musical sources marked   or .

Virtual Surround Back (VIRTL SB)

(VSX-D512 only)

The Virtual Surround Back effect simulates 6.1 surround channel listening, giving the impression that there is a surround back speaker in your system when listening to a 5.1 channel source.

Expanded

This mode is especially designed to give sound depth to stereo sources. The overall effect builds a dynamic and broad sound space, allowing two-channel (stereo) signals to imitate a five speaker sound. Use with Dolby Pro Logic for a stereo surround effect. You can also use with Dolby Digital sources for a wider stereo field than the Standard modes.

5-Channel Stereo

This can be selected to give multi-channel sound to a stereo source, using all the speakers in your setup.

Choosing the input signal

You need to hook up a component to both analog and digital inputs on the back of the receiver to select between input signals.

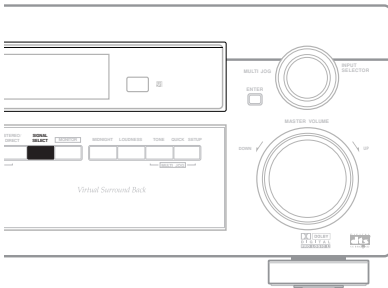

- Press **SIGNAL SELECT (front panel)** to select the input signal corresponding to the source component.

Each press switches between **AUTO**, **DVD 5.1 ch**, **ANALOG** and **DIGITAL**. The default is **AUTO**.

When set to **DIGITAL**, **DL** **DIGITAL** lights when a Dolby Digital signal is input, and **DTS** lights when a DTS signal is input.



Note

- DVD 5.1 ch is only available when **DVD/LD** is selected as the source.
- This receiver can only play back Dolby Digital, PCM (32kHz, 44kHz, 48kHz, and 96 kHz) and DTS digital signal formats. With other digital signal formats, set to **ANALOG**.
- You may get digital noise when a LD or CD player compatible with DTS is playing an analog signal. To prevent noise, make the proper digital connections (page 14) and set the signal input to **DIGITAL**.
- Some DVD players don't output DTS signals. For more details, refer to the instruction manual supplied with your DVD player.
- You can only select **DIGITAL** if the source you selected is assigned to a digital input. See page 38 for more on the digital input settings.

Using Stereo/Direct

When you select **STEREO** or **DIRECT**, you will hear the source through just the front left and right speakers (and possibly your subwoofer depending on your speaker settings). Dolby Digital and DTS multichannel sources are downmixed to stereo. See the previous page for more on these modes.

- Press **STEREO/DIRECT (STEREO on the VSX-D412 remote control)** repeatedly to switch between the two options.



Note

If you switch on Midnight listening, Loudness, or the Tone controls when **DIRECT** is selected, the receiver automatically switches to **STEREO**.

Listening to multi-channel playback

VSX-D412

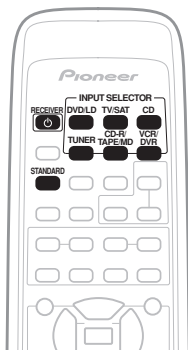

VSX-D512

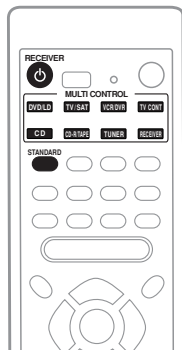

- 1 Switch on the playback component.
- 2 Switch on the receiver.
- 3 Select the source you want to playback.

Use the **INPUT SELECTOR** (VSX-D412)/**MULTI CONTROL** (VSX-D512) buttons on the remote (or the **MULTI JOG/INPUT SELECTOR** dial on the front panel).

4 Press STANDARD.

For multi-channel sources, Dolby/DTS decoding is selected automatically according to the source and shows in the display.

For a two channel source, you can press **STANDARD** repeatedly to select the Pro Logic II mode you want:



Refer to page 30 for more details about each mode.

- 5 Start playback of the component you selected in step 1.

Using Advanced Surround

Dolby Pro Logic, Dolby Digital and DTS signal processing is done automatically corresponding to the input signal.

- Press **ADVANCED SURROUND** repeatedly to cycle the sound options.

Each press changes the display as follows:

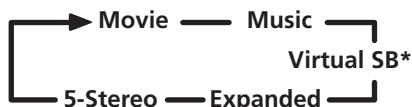

*VSX-D512 only.

Refer to page 30 for more details about each surround effect.

Note

- The Movie, Music, and Expanded effects of Dolby/DTS can be adjusted in the range of 10 to 90 (the default setting is 70) by pressing **EFFECT +/-**. The effect level can be set for each of these Advanced Surround mode. The Standard and Stereo modes cannot be changed.

Using Loudness and Midnight listening

The Loudness listening feature can be used to get good bass and treble from music sources at low volume levels.

The Midnight listening feature allows you to hear effective surround sound of movies at low volume levels. The effect automatically adjusts according to the volume at which you're listening.

- **Press MIDNIGHT/LOUDNESS.**

Each press cycles through the effects as follows:



You can also press **MIDNIGHT** or **LOUDNESS** on the front panel. Each press switches the effect on or off.

Using the tone controls

Depending on what you are listening to, you may want to adjust the bass or treble using the front panel tone control.

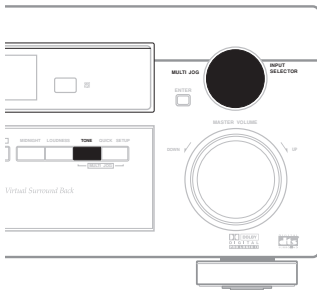

- 1 **Press TONE to select the frequency you want to adjust.**

Each press switches between **BASS** and **TREBLE**.

- 2 **Use the MULTI JOG/INPUT SELECTOR dial to change the amount of bass or treble as necessary.**

Wait about five seconds for your changes to be input automatically.



Note

- The tone controls can only be used with the Stereo sound mode.
- When the receiver is switched to Direct, using the tone controls automatically switches the receiver to Stereo mode.

Playing other sources

VSX-D412

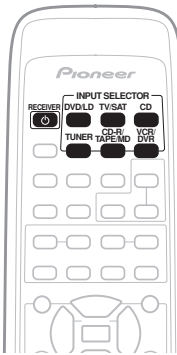

VSX-D512

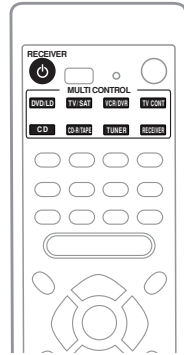

- 1 **Turn on the power of the playback component.**

- 2 **Turn on the power of the receiver.**

- 3 **Select the source you want to playback.**

Use the **INPUT SELECTOR** (VSX-D412)/**MULTI CONTROL** (VSX-D512) buttons on the remote (or the **MULTI JOG/INPUT SELECTOR** dial on the front panel).

- 4 **Start playback of the component you selected in step 1.**

Selecting the multi-channel analog inputs

Connect a DVD player with 5.1 channel output to listen to 5.1 channel playback.

1 Select DVD/LD if it is not already selected.

Use the **INPUT SELECTOR** (VSX-D412)/**MULTI CONTROL** (VSX-D512) buttons on the remote (or the **MULTI JOG/INPUT SELECTOR** dial on the front panel).

2 Press **SIGNAL SELECT** (front panel) repeatedly to select **DVD 5.1 ch**.

To cancel 5.1 channel playback, use the **SIGNAL SELECT** button to select an input signal (other than **DVD 5.1 ch**).



Note

- When 5.1 channel playback is selected, you can't use the **SIGNAL SELECT**, **INPUT ATT**, **TONE**, and **MIDNIGHT/LOUDNESS** buttons, as well as the Standard, Advanced Surround, and Stereo/Direct sound modes.
- When 5.1 channel playback is selected, only the volume and channel levels can be set.

Choosing your receiver setup

Even though you may already have your system up and running after using the *5 minute guide* on pages 8 to 12, you should also be sure to complete the following set up operations to ensure the best possible surround sound. This is particularly important when using Dolby surround. You only need to make these settings once (unless you change the placement of your current speaker system or add new speakers, etc.). Refer to the following pages for details on each of the settings.

 **Note**

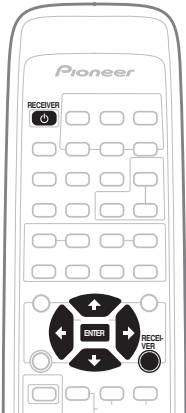

If you are using the Pioneer S-FCRW230 speaker system, you'll have to set the Crossover frequency to 200 Hz. You can leave the Speaker setting and the Subwoofer setting in the default settings.

VSX-D412

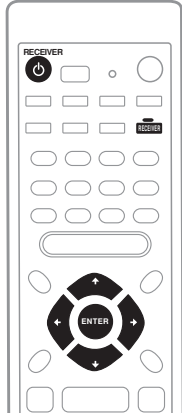

VSX-D512



- 1 Press  **RECEIVER** to turn the power on. The **STANDBY** indicator goes out.
- 2 Press **RECEIVER**.
- 3 Use  or  to choose the option you want to adjust.

It will be easiest to adjust each of the settings in turn, following the order below (and on the following pages). The current setting is shown for each option as you cycle through the display.

Speaker setting (page 36)

Specify the number and type of speakers you have connected.

Subwoofer setting (page 36)

Specify how the subwoofer is used.

Crossover frequency setting (page 36)

Determine which frequencies will be sent to the subwoofer (or large speakers).

LFE attenuator setting (page 37)

Specify the peak level for the LFE channel.

Front speaker distance setting (page 37)

Specify the distance from your listening position to your front speakers.

Center speaker distance setting (page 37)

Specify the distance from your listening position to your center speaker.

Surround speaker distance setting (page 37)

Specify the distance from your listening position to your surround speakers.

Dynamic range control setting (page 38)

Compress the dynamic range of the sound track.

Dual mono setting (page 38)

Isolate one channel when listening to discs with dual mono encoding.

Coaxial digital input setting (page 38)

Specify the component to be assigned to the coaxial digital input.

Optical digital input setting (page 38)

Specify the component to be assigned to the optical digital input.

4 Use ↑ or ↓ to adjust the setting.

The setting is entered automatically.

5 Repeat steps 3 and 4 to set other surround modes.**6 When you're done, press ENTER to exit.****Note**

The setting display is automatically exited after 20 seconds of inactivity.

Speaker setting

- Default setting: **S** (all speakers)

You must let the receiver know how many speakers you have, and how big they are. The size you choose (large or small) determines how much bass is sent from the receiver to the speakers.

In the display, **F**, **C**, and **S** refer to front, center, and surround speakers respectively. Speaker size is denoted as **L** for large speakers, **S** for small speakers, and * (asterisk) if no speaker is connected.

- **Cycle through the available choices using ↑ or ↓ and choose a configuration that matches your speaker setup.**

One of the following configurations should match your setup:

**Note**

- If the cone size (diameter) of the speaker is larger than 5 inches, set the speaker size to **L**.
- If you're not using a subwoofer, we recommend setting the front speakers to **L**.

Subwoofer setting

- Default setting: **ON**

You can choose whether the subwoofer is used or not. Use the plus (**PLS**) setting for extra bass.

- **Use ↑ or ↓ to select subwoofer ON, PLS or OFF.**

**Note**

- If you chose the small front speaker setting, **SUBWF ON** is automatically set and locked.
- When you select the plus setting, you will get the bass sounds from the subwoofer even if the front speakers are set to **L**.

Crossover frequency setting

- Default setting: **100 Hz**

Crossover frequency is the point where the receiver divides the high and low sounds (the frequencies) between the speakers. Since most smaller speakers can't handle deep bass tones, you can send these sounds to the subwoofer (or if you don't have a subwoofer, the large (**L**) speakers in your system) instead of the speakers set to small (**S**) in your setup. Choose the point at which you want the frequency routed to the subwoofer (or **L** speakers).

We recommend setting this to 200 Hz if your **S** speakers are smaller bookshelf-type speakers.

- **Use ↑ or ↓ to specify the crossover frequency for your small speakers (100 Hz, 150 Hz or 200 Hz).**

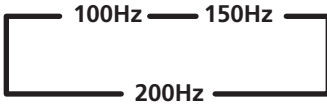

100 Hz

Sends bass frequencies below 100 Hz to the subwoofer (or **L** speakers).

150 Hz

Sends bass frequencies below 150 Hz to the subwoofer (or **L** speakers).

200 Hz

Sends bass frequencies below 200 Hz to the subwoofer (or **L** speakers).



Note

If all speakers (front, center, and surround) are set to **L**, the crossover frequency can't be set because there are no **S** speakers (***) appears in the display).

LFE attenuator setting

- Default setting: **0 dB**

Dolby Digital and DTS audio sources include ultra-low bass tones. Set the LFE attenuator as necessary to prevent the ultra-low bass tones from distorting the sound from the speakers.

- Use **↑** or **↓** to set the attenuation level (0 dB, 10 dB or ** dB(∞)).



Note

When ∞ is selected (** appears in the display), LFE is not available.

Front speaker distance setting

- Default setting: **10 ft.**

Sets the distance from the front speakers to the listening position.

- Use **↑** or **↓** to set the distance of the front speakers from the main listening position (within a 30 foot range).

Center speaker distance setting

- Default setting: **10 ft.**

The center speaker is normally placed directly in the front of the listening room and closer to the listening position than the front speakers. This means that the sound from the center speaker will be heard before the front speakers. To prevent this, set the center speaker distance setting to delay the sound from the center speaker so that the sound from the front and center speakers will be heard at the same time.

- Use **↑** or **↓** to set the distance of the center speaker from the main listening position (within a 30 foot range).



Note

When **C*** is selected in the speaker setting, the center distance can't be set.

Surround speaker distance setting

- Default setting: **10 ft.**

Like the center speaker, you should set the distance of the surround speakers accurately to hear sounds coming from both front and surround speakers at the same time.

- Use **↑** or **↓** to set the distance of the surround speakers from the main listening position (within a 30 foot range).

**Note**

When **S*** is selected in the speaker setting, the surround distance cannot be set.

Dynamic range control setting

- Default setting: **OFF**

Dynamic range is the difference between the loudest and softest sounds in any given signal. With this setting, you can compress the dynamic range, so that low level sounds can be heard more easily (sounding relatively louder) yet louder sounds won't be too overbearing.

- **Press \uparrow or \downarrow to set the dynamic range control (OFF, MAX, or MID).**

**Note**

- When listening at low volumes, set to **MAX** for maximum dynamic range compression.
- Dynamic range control is effective only when a Dolby Digital signal is being played back.

Dual mono setting

- Default setting: **ch1**

The dual mono setting can only be used when listening to Dolby Digital discs with dual mono encoding. These discs are not widely used, but are sometimes used when it is necessary to have one language on one channel and a different language on the other. With this setting you can choose which channel in the dual mono setting you want to listen to.

If Dolby Digital mode is switched on, you will hear the channel you have selected (either **ch1** or **ch2**) through your center speaker. With Dolby Digital mode off, or if you don't have a center speaker, you will hear the channel you have selected through both front speakers. In the **L**

ch 1. R ch 2 setting, the left front speaker will play channel 1 and the right front speaker will play channel 2.

- **Use \uparrow or \downarrow to cycle through the possible DUAL MONO settings.**

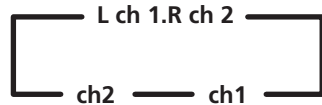
**Coaxial digital input setting**

- Default setting: **DVD**

Here you tell the receiver what component you have hooked up to the coaxial digital input jack.

- **Use \uparrow or \downarrow to select the coaxial digital input (DVD, TV, CD, CD-R, VCR or OFF).**

After you assign a component to the digital jack, whenever you select that component, for example a DVD player, the receiver automatically changes to the digital input setting and **DIGITAL** shows in the display.

Optical digital input setting

- Default setting: **TV**

Here you tell the receiver what component you have hooked up to the optical input jack.

- **Use \uparrow or \downarrow to select the optical digital input (DVD, TV, CD, CD-R, VCR, or OFF).**

After you assign a component to the digital jack, whenever you select that component, for example a DVD player, the receiver automatically changes to the digital input setting and **DIGITAL** shows in the display.

Setting the relative volume level of each channel

- Default setting: **0 dB**

For best surround sound playback, you should set the relative channel levels from the main listening position. You can set separate levels for each surround mode.

1 Press STANDARD.

2 Press TEST TONE to output the test tone.

The test tone is output in the following order (depending on the speaker setting):

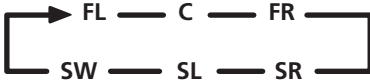

Note

If you don't hear a test tone from one of your speakers, please refer to *Speaker setting* on page 36 to make sure you have correctly specified your speaker setup.

3 Press MASTER VOLUME +/- to adjust the volume to an appropriate level.

4 Use LEVEL +/- to adjust the speaker levels in turn.

You should hear the test tone at the same volume from each speaker when seated in the main listening position. The channel level range is ± 10 dB.

5 When you're done, press TEST TONE to turn off the test tone.

Tip

The speaker volume can be adjusted without outputting the test tone by pressing **CH SELECT** and then using **LEVEL +/-**.

Note

- Test tone is only output in Standard modes.
- Since the subwoofer transmits an ultra-low frequency its sound may seem quieter than it actually is.

VSX-D412

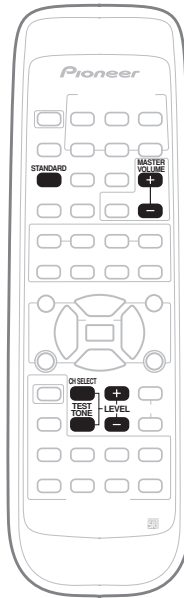

VSX-D512

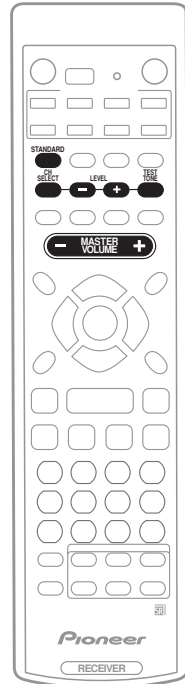

Listening to the radio

The following steps show you how to tune to FM and AM radio broadcasts using the automatic (search) and manual (step) tuning functions. Once you are tuned to a station you can memorize the frequency for recall later—see *Saving station presets* on the next page for more on how to do this.

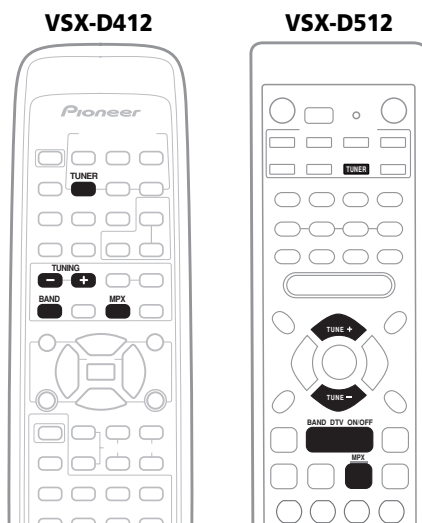

1 Press the TUNER button on the remote control to select the tuner.

2 Use the BAND button to change the band (FM or AM), if necessary.

Each press switches the band between FM and AM.

3 Tune to a station.

There are three ways to do this:

Automatic tuning

To search for stations in the currently selected band, press and hold the tuning buttons (**TUNING** (VSX-D412)/ **TUNE** (VSX-D512) **+ / -**) for about a second. The receiver will start searching for the next station, stopping when it has found one. Repeat to search for other stations.

Manual tuning

To change the frequency one step at a time, press the tuning buttons (**TUNING** (VSX-D412)/ **TUNE** (VSX-D512) **+ / -**).

High speed tuning

Press and hold the tuning buttons (**TUNING** (VSX-D412)/ **TUNE** (VSX-D512) **+ / -**) for high speed tuning. Release the button at the frequency you want.

Tuning directly to a station (VSX-D512 only)

Sometimes, you'll already know the frequency of the station you want to listen to. In this case, you can simply enter the frequency directly using the number buttons on the remote control.

1 Press the TUNER button on the remote control to select the tuner.

2 Use the BAND button to change the band (FM or AM), if necessary.

Each press switches the band between FM and AM.

3 Press D.ACCESS (Direct Access).

4 Use the number buttons to enter the frequency of the radio station.

For example, to tune to **106.00** (FM), press **1, 0, 6, 0, 0**.

If you make a mistake halfway through, press **D.ACCESS** twice to cancel the frequency and start over.

Improving FM stereo sound

If the **TUNED** or **STEREO** indicators don't light when tuning to an fm station because the signal is weak, press the **MPX** button to switch the receiver into mono reception mode. This should improve the sound quality and allow you to enjoy the broadcast.

Saving station presets

If you often listen to a particular radio station, it's convenient to have the receiver store the frequency for easy recall whenever you want to listen to that station. This saves the effort of manually tuning in each time. This unit can memorize up to 30 stations, stored in three banks, or classes, (A, B and C) of 10 stations each. When saving an FM frequency, the **MPX** setting (see previous page) is also stored. Use the front panel controls to store station presets.

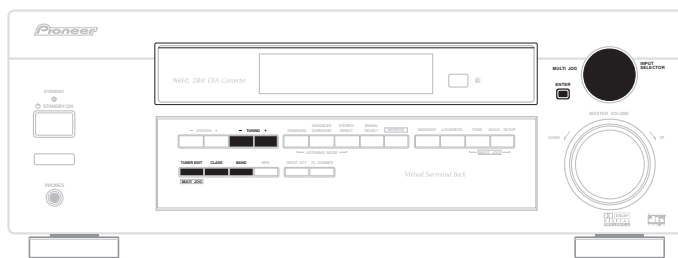

VSX-D412

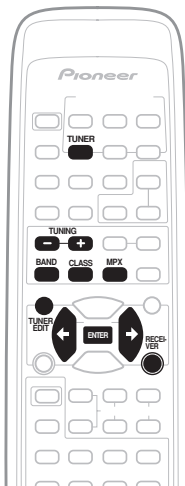

VSX-D512

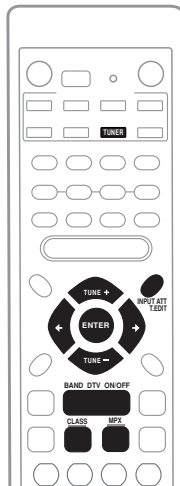

1 Tune to a station you want to memorize.

See *Listening to the radio* (previous page) for more on this.

2 If you're using the remote control, press RECEIVER (VSX-D412 only).

3 Press TUNER EDIT (T. EDIT on the VSX-D512 remote).

The display shows **ST. MEMORY**, then a blinking memory class.

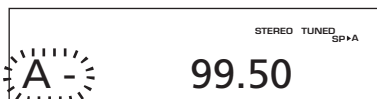

4 Press CLASS to select one of the three classes then press ← → to select the station preset you want.

You can also use the the **MULTI JOG/INPUT SELECTOR** dial (front panel) to select a station preset.

5 Press ENTER.

After pressing **ENTER**, the preset class and number stop blinking and the receiver stores the station.

Naming station presets

For easier identification, you can name your station presets.

1 Choose the station preset you want to name.

See *Listening to station presets* (this page) for how to do this.



2 If you're using the remote control, press RECEIVER (VSX-D412 only).

3 Press TUNER EDIT (T. EDIT on the VSX-D512 remote).

The display shows **ST. NAME**, then a blinking cursor at the first character position.

4 Input the name you want.

Names can be up to four characters long.

- Use the front panel **MULTI JOG/INPUT SELECTOR** dial or the remote control   buttons to select characters.
- Press **ENTER** to confirm a character. If no character is input, a space is input.
- The name is stored when **ENTER** is pressed after choosing the fourth character.



Note

To erase a station name, simply repeat steps 1-3 and input four spaces instead of a name.



Tip

Once you have named a station preset, you can press **DISPLAY** when listening to a station to switch the display between the name and the frequency.

Listening to station presets

Having stored up to 30 stations (see previous page), preset stations can be easily recalled.

1 Press the TUNER button on the remote control to select the tuner.

2 Press CLASS to select the class in which the station is stored.

Press repeatedly to cycle through classes A, B and C.

3 Press STATION +/- (ST +/- on the VSX-D512 remote) to select the station preset you want.



Note

- If the receiver is left disconnected from the AC power outlet for an extended period, the station memories will be lost and will have to be reprogrammed.

Making an audio or a video recording

You can make an audio or a video recording from the built-in tuner, or from an audio or video source connected to the receiver (such as a CD player or TV) through the analog jacks. You will need to connect a CD recorder, tape deck, MD, VCR, or DVR deck to the **CD-R/TAPE/MD** or **VCR/DVR** outputs on the receiver to do so (see pages 14–15 for more on this).



Note

The receiver's volume, balance, tone (bass, treble, loudness), and surround effects have no effect on the recorded signal.

1 Select the source you want to record.

Use the **INPUT SELECTOR** (VSX-D412)/**MULTI CONTROL** (VSX-D512) buttons on the remote (or **MULTI JOG/INPUT SELECTOR** dial on the front panel).

2 Prepare the source you want to record.

Tune to the radio station, load the CD, video, DVD etc.

3 Prepare the recorder (connected to either the **CD-R/TAPE/MD** or **VCR/DVR** outputs).

Insert a blank tape, MD, video etc. into the recording device and set the recording levels.

Refer to the instructions that came with the recorder if you are unsure how to do this. Most video recorders set the audio recording level automatically—check the component's instruction manual if you're unsure.

4 Start recording, then start playback of the source component.

Monitoring your recording

You can listen to (monitor) the recording as it's being made using the **MONITOR** button on the front panel (a cassette deck would have to have a record monitor function).

- **Press the MONITOR button to switch between the recorded signal and the original source signal.**

Setting the remote to control other components (VSX-D512 only)

There are several ways to set your remote to control the other components in your system. The easiest way to do this is to assign the component's manufacturer preset code (listed on pages 51–52) to one of the **MULTI CONTROL** buttons on the remote control.

The buttons can be set to control the following components:

| Button | Controllable Components |
|-------------------|-------------------------------------|
| DVD/LD: | DVD or LD player |
| TV/SAT: | TV or Satellite tuner |
| VCR/DVR: | VCR or Digital Video Recorder |
| CD: | CD player |
| CD-R/TAPE: | CD Recorder, Tape deck or MD player |
| TV CONT: | TV or Cable TV tuner |
| TUNER: | FM/AM tuner |



Note

The remote control will exit an operation after 1 minute of inactivity.

Selecting preset codes (VSX-D512 only)

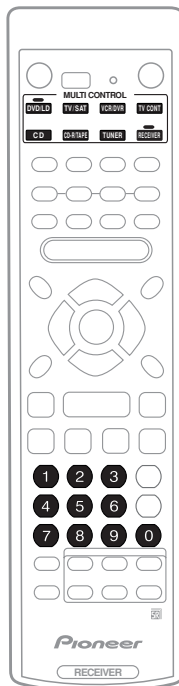

1 While pressing the RECEIVER button press and hold the 1 button.

The LED blinks.

To cancel the preset mode at any time press **RECEIVER**. The remote control will also return to the previous mode after one minute of inactivity.

2 Press the MULTI CONTROL button for the component you want to control.

The LED lights.

3 Use the number buttons to enter the 3 digit setup code (see pages 51 for "Preset Code List").

The LED blinks again.

If the correct code has been input the power of the component being input will turn on or off.

The power of the component being input will only turn on or off if that component is able to be turned on directly by remote control.

4 Repeat steps 2 through 3 for the other components you want to control.

5 When you're done, press RECEIVER.



Note

- You can only input a code for the component type written on each **MULTI CONTROL** button (except **RECEIVER** and **TUNER**).
- Even if you don't input a preset code for the TV (**TV/SAT MULTI CONTROL** button) you will be able to control your TV using the dedicated **TV CONTROL** on the remote if you have assigned it to the **TV CONT** button.
- You may not be able to use a particular code even if it is listed on pages 51.
- The remote control buttons will not be able operate other equipment unless preset with the method above.

Direct function (VSX-D512 only)

- Default setting: **ON**

You can use the direct function feature to control one component using the remote control while at the same time, using your receiver to playback a different component. This could let you, for example, use the remote control to set up and listen to a CD on the receiver and then use the remote control to rewind a tape in your VCR while you continue to listen to your CD player.

When direct function is on, any component you select (using the **MULTI CONTROL** buttons) will be selected by both the receiver and the remote control. When you turn direct function off, you can operate the remote control without affecting the receiver.

1 While pressing the RECEIVER button press and hold the 4 button.

The LED blinks.

2 Press the MULTI CONTROL button for the component you want to control.

The LED lights.

3 Use the number buttons to enter either 1 (direct on) or 2 (direct off).

The LED blinks again.

4 Repeat steps 2 through 3 for the other components you want to control.

5 When you're done, press RECEIVER.



Note

- You can't use direct function for **TUNER**.

Clearing the Preset Codes (VSX-D512 only)

You can clear all presets and restore the factory default settings.









1 While pressing the RECEIVER button press and hold the 0 button for three seconds.

The LED on the remote control blinks three times indicating all the preset codes have been cleared. The remote control will reset as described in the box below.

| Button | Preset Code | Component |
|------------|-------------|--------------|
| DVD/LD: | 000 | DVD |
| TV/SAT: | 600 | TV |
| VCR/DVR: | 456 | DVD Recorder |
| CD: | 300 | CD |
| CD-R/TAPE: | 345 | CD |
| TV CONT: | 600 | TV |
| TUNER: | 500 | TUNER |

Controls for TVs (VSX-D512 only)

This remote control can control components after entering the proper codes (see pages 45–46). Use the **MULTI CONTROL** buttons to select the component.

| Button (s) | Function | Components |
|--|--|------------------------------|
| TV  | Switches the DTV on or off. | DTV |
| | Switches the TV or CATV between standby and on. | Cable TV/Satellite TV/TV |
| INPUT SELECT | Switches the TV input. (Not possible with all models.) | TV |
| CHANNEL +/- | Selects channels. | Cable TV/Satellite TV/TV/DTV |
| VOLUME +/- | Adjust the TV volume. | Cable TV/Satellite TV/TV/DTV |
| TOP MENU | Press to display the DTV menu. | DTV |
| MENU | Select different menus from the DTV functions. | DTV |
| | Select the menu screen. | Cable TV/Satellite TV/TV |
| AUDIO | Use to switch DTV audio tracks. | DTV |
| GUIDE | Use as the GUIDE button for navigating. | Cable TV/Satellite TV/TV/DTV |
|  | Use to choose the BLUE commands on a DTV menu. | DTV |
|  | Use to choose the GREEN commands on a DTV menu. | DTV |
|  | Use to choose the RED commands on a DTV menu. | DTV |
|  | Use to choose the YELLOW commands on a DTV menu. | DTV |
|  | Press to get information on DTV programs. | DTV |
|  | Switches DTV on or off. | DTV |
|  | Use to select closed captioning with DTV. | DTV |
| Number Buttons | Use to select a specific TV channel. | Cable TV/Satellite TV/TV/DTV |
| +10 button | Use to add a decimal point when selecting a specific TV channel. | DTV |
| ENTER/DISC | Use to enter a channel. | Cable TV/Satellite TV/TV/DTV |

| Button (s) | Function | Components |
|------------------------|--|----------------------------------|
| ←→↑↓ & ENTER | Select or adjust and navigate items on the menu screen. ENTER brings up the DTV menus. | DTV |
| | Press to select or adjust and navigate items on the menu screen. | Cable TV/Satellite TV/TV/ DTV |

**Note**

The six **TV CONTROL** buttons on the remote control are dedicated to control the TV assigned to the **TV CONT** button. Thus if you only have one TV to hook up to this system assign it to the **TV CONT MULTI CONTROL** button. If you have two TVs, assign the main TV to the **TV CONT** button.

Controls for other components (VSX-D512 only)

This remote control can control these components after entering the proper codes (see pages 45–46). Use the **MULTI CONTROL** buttons to select the component.

| Button (s) | Function | Components |
|-----------------|---|--|
| SOURCE ⏻ | Press to switch the component between standby and on. | CD/MD/CD-R/VCR/DVD/LD/ DVR player/Cassette deck |
| ⏮ | Press to return to the start of the current track. Repeated presses skips to the start of previous tracks. | CD/MD/CD-R/DVD/LD player |
| | Play the reverse side of the tape on a reversible deck. | Cassette deck |
| ⏭ | Press to advance to the start of the next track. Repeated presses skips to the start of following tracks. | CD/MD/CD-R/LD player |
| | Play the forward side of the tape on a reversible deck. | Cassette deck |
| ⏸ | Pause playback or recording. | CD/MD/CD-R/VCR/DVD/LD/ DVR player/Cassette deck |
| ▶ | Start playback. | CD/MD/CD-R/VCR/DVD/LD/ DVR player/Cassette deck |

| Button (s) | Function | Components |
|-----------------|---|--|
| ▶▶ | Hold down for fast forward playback. | CD/MD/CD-R/VCR/DVD/LD/ DVR player/Cassette deck |
| ◀◀ | Hold down for fast reverse playback. | CD/MD/CD-R/VCR/DVD/LD/ DVR player/Cassette deck |
| ■ | Stops playback (on some models, pressing this when the disc is already stopped will cause the disc tray to open). | CD/MD/CD-R/VCR/DVD/LD/ DVR player/Cassette deck |
| Number buttons | Directly access tracks on a program source. | CD/MD/CD-R/VCR/LD player |
| | Use the number buttons to navigate the on-screen display. | DVD/DVR player |
| +10 button | Selects tracks higher than 10. (For example, press +10 then 3 to select track 13.) | CD/MD/CD-R/VCR/LD player |
| ENTER | Changes the search mode. | DVD |
| /DISC | Chooses the disc. | Multiple CD player |
| | Use as the ENTER button. | VCR |
| | Displays the setup screen for DVR players. | DVR player |
| | Changes sides of the LD. | LD player |
| MENU | Displays menus concerning the current DVD or DVR you are using. | DVD/DVR player |
| ↑ | Pauses the tape. | Cassette deck |
| ↓ | Stops the tape. | Cassette deck |
| ENTER | Starts playback. | Cassette deck |
| ↔/⇒ | Fast rewinds/fast forwards the tape. | Cassette deck |
| ↔⇒↑↓ & ENTER | Navigates DVD menu/options. | DVD/DVR Player |
| CHANNEL +/- | Selects channels. | VCR/DVR Player |
| TOP MENU | Displays the disc 'top' menu of a DVD. | DVD/DVR Player |
| AUDIO | Changes the audio language or channel. | DVD/DVR Player |
| GUIDE | Displays/changes the subtitles on multilingual DVDs. | DVD/DVR Player |

Preset Code List (VSX-D512 only)

You should have no problem controlling a component if you find the manufacturer in this list, but please note that there are cases where codes for the manufacturer in the list will not work for the model that you are using. There are also cases where only certain functions may be controllable after assigning the proper preset code.



Note

The TV, STB and DTV codes can only be set to the **TV/SAT** or **TV CONT** button.

DVD

| Manufacturer | Code |
|----------------------|--------------------|
| TOSHIBA | 001 |
| SONY | 002 |
| PANASONIC | 003 |
| JVC | 004 |
| SAMSUNG | 005 |
| SHARP | 006 |
| AKAI | 007 |
| RCA | 009, 011 |
| DENON | 003, 010 |
| HITACHI | 012 |
| PHILIPS | 013 |
| ZENITH | 014 |
| THOMSON | 015 |
| SONY (video game) | 016 |
| LOEWE | 013 |
| GOLDSTAR | 014 |
| MICROSOFT | 017 (Video game) |
| PIONEER | 000, 003, 008, 111 |

LD

| Manufacturer | Code |
|--------------|------------------|
| SONY | 101 |
| PANASONIC | 105, 106 |
| PHILIPS | 104 |
| KENWOOD | 103 |
| mitsubishi | 100 |
| RCA | 107 |
| PIONEER | 100, 111(DVD/LD) |

TV TV/SAT TV CONT

| Manufacturer | Code |
|--------------|---|
| RCA | 601, 610, 615, 616, 617, 618, 609 |
| ZENITH | 603, 620 |
| MAGNAVOX | 607, 610, 603, 612, 629 |
| GE | 601, 608, 607, 610, 617, 602, 628, 618, 611 |
| PHILIPS | 607 |

| | |
|-------------|-------------------------|
| SONY | 604 |
| PANASONIC | 607, 608, 622 |
| TOSHIBA | 605, 602, 626, 621 |
| SHARP | 602, 619, 627 |
| HITACHI | 606, 610, 624, 625, 618 |
| SANYO | 621, 614 |
| mitsubishi | 609, 610, 602, 621 |
| GOLDSTAR | 610, 623, 621, 602 |
| JVC | 613, 623 |
| RADIO SHACK | 610, 623, 621, 602 |
| FUNAI | 658 |
| GRANDIENTE | 630 |
| LOEWE | 607 |
| PIONEER | 600 |

STB (SATELLITE/CATV) TV/SAT TV CONT

| Manufacturer | Code |
|--------------|--|
| JERROLD | 711, 701, 702, 712, 704, 713, 703, 714, 716, 715 |
| S. ATLANTA | 705, 706, 708, 709 |
| ZENITH | 707, 717, 710 |
| PIONEER | 700 |

On digital STB TV/SAT TV CONT

| Manufacturer | Code |
|--------------|---------------|
| RCA | 201, 203, 209 |
| SONY | 202 |
| ECHOSTAR | 205 |
| PRIMESTAR | 206 |
| BELL | 208 |
| PIONEER | 200, 207, 231 |

DTV TV/SAT TV CONT

| Manufacturer | Code |
|--------------|--------------------|
| PIONEER | 229, 207, 231, 232 |
| PANASONIC | 226, 230 |
| JVC | 227 |
| TOSHIBA | 228 |

TUNER

| Manufacturer | Code |
|--------------|------|
| PIONEER | 500 |

VCR

| Manufacturer | Code |
|---------------------|--|
| ORION | 424 |
| FUNAI | 441 |
| RCA | 401, 406, 408, 414, 405, 413 411, 415 |
| ZENITH | 403, 404, 417 |
| MAGNAVOX | 414, 408, 426, 403 |
| FISHER | 410, 426, 412, 427, 425, 420 |
| PANASONIC | 408, 432, 433 |
| TOSHIBA | 405, 409, 426 |
| JVC | 428, 430, 429, 408, 414, 431 407 |
| HITACHI | 408, 401, 406, 436, 434 |
| SONY | 416, 417, 404, 408, 457, 458 459 |
| MITSUBISHI | 409, 420, 421, 422, 423, 424 408, 407 |
| SANYO | 410, 412, 425, 435 |
| SHARP | 402, 418, 419 |
| GOLDSTAR | 411, 409 |
| OPTIMUS | 408, 432, 433, 402, 418, 419 |
| GRADIENTE | 441 |
| LOEWE | 414, 432 |
| PIONEER | 400 |

DVD Recorder

| Manufacturer | Code |
|---------------------|-------------|
| PIONEER | 456 |

TAPE

| Manufacturer | Code |
|---------------------|-------------|
| DENON | 810 |
| FISHER | 813 |
| JVC | 802 |
| KENWOOD | 804, 807 |
| ONKYO | 808, 809 |
| OPTIMUS | 800 |
| PANASONIC | 803 |
| SONY | 801, 806 |
| TEAC | 805 |
| TECHNICS | 803 |
| YAMAHA | 811, 812 |
| PIONEER | 800 |

CD

| Manufacturer | Code |
|---------------------|-------------------------|
| DENON | 309, 346 |
| JVC | 303 |
| KENWOOD | 310, 311, 321 |
| MARANTZ | 323, 312, 324, 346 |
| ONKYO | 320, 308, 307 |
| OPTIMUS | 300 |
| PANASONIC | 304, 326 |
| PHILIPS | 312, 322, 346 |
| RCA | 302, 319, 313 |
| SANYO | 313 |
| SONY | 301, 316, 317, 318 |
| TEAC | 305, 306, 327, 324, 325 |
| TECHNICS | 304, 326 |
| YAMAHA | 315, 314, 328 |
| PIONEER | 300, 345 |

MD

| Manufacturer | Code |
|---------------------|---------------|
| SONY | 901 |
| KENWOOD | 903 |
| SHARP | 902 |
| TEAC | 904 |
| ONKYO | 905 |
| DENON | 906 |
| PIONEER | 900, 902, 907 |

CD-R

| Manufacturer | Code |
|---------------------|-------------|
| PHILIPS | 346 |
| PIONEER | 345 |

Troubleshooting

Incorrect operations are often mistaken for trouble and malfunctions. If you think that there is something wrong with this component, check the points below. Sometimes the trouble may lie in another component. Investigate the other components and electrical appliances being used. If the trouble cannot be rectified even after exercising the checks listed below, ask your nearest Pioneer authorized service center or your dealer to carry out repair work.

| Problem | Remedy |
|--|--|
| The power does not turn on. | <ul style="list-style-type: none"> • Connect the power plug to the wall outlet. • Disconnect the power plug from the outlet, and insert again. • Make sure there are no loose strands of speaker wire touching the rear panel. This could cause the receiver to shut off automatically. |
| No sound is output when a function is selected. | <ul style="list-style-type: none"> • Make sure the component is connected correctly (refer to pages 13–18). • Press MUTE on the remote control to turn muting off. • Adjust the MASTER VOLUME. • Press the MONITOR button to turn monitoring off. |
| No image is output when a function is selected. | <ul style="list-style-type: none"> • Make sure the component is connected correctly (refer to pages 13–15). • Select the correct component (use the INPUT SELECTOR buttons). |
| Considerable noise in radio broadcasts. | <ul style="list-style-type: none"> • Tune in the correct frequency. • Connect the antenna (refer to pages 16–17). • Route any other cables away from the antenna terminals and wires. • Fully extend the FM wire antenna, position for best reception, and secure to a wall. • Connect an outdoor FM antenna (refer to page 17). • Adjust the direction and position for best reception. • Connect an additional internal or external AM antenna (refer to pages 16–17). • Turn off the equipment causing the noise or move it away from the receiver. • Place the antenna farther away from the equipment causing the noise. |
| Broadcast stations cannot be selected automatically. | <ul style="list-style-type: none"> • Connect an outdoor antenna (refer to page 17). |

| Problem | Remedy |
|--|--|
| No sound from surround or center speakers. | <ul style="list-style-type: none"> • Refer to <i>Speaker setting</i> on page 36 to check the speaker settings. • Refer to <i>Setting the relative volume level of each channel</i> on page 39 to check the speaker levels. • Connect the speakers properly (refer to pages 18–19). |
| Noise during playback of a cassette deck. | <ul style="list-style-type: none"> • Move the cassette deck further from your receiver, until the noise disappears. |
| Sound is produced from other components, but not from LD or DVD player. | <ul style="list-style-type: none"> • Set the SIGNAL SELECT to AUTO, DIGITAL or ANALOG according to the type of connections made. (refer to page 31). • Set the digital input settings correctly (refer to page 38). • Make digital connections (refer to page 14) and set the SIGNAL SELECT to DIGITAL (refer to page 31). • Refer to the instruction manual supplied with the DVD player. |
| No sound is output or a noise is output when software with DTS is played back. | <ul style="list-style-type: none"> • Set the digital volume level of the player to full, or to the neutral position. • Refer to the manual supplied with the DVD player. |
| When a search is performed by a DTS compatible CD player during playback, noise is output. | <ul style="list-style-type: none"> • This is not a malfunction, but be sure to turn the volume down to prevent the output of loud noise from your speakers. |
| Can't operate the remote control. | <ul style="list-style-type: none"> • Replace the batteries (refer to page 6). • Operate within 23 feet (7 m), 30° of the remote sensor on the front panel (refer to page 7). • Remove the obstacle or operate from another position. • Avoid exposing the remote sensor on the front panel to direct light. |
| The display is dark or off. | <ul style="list-style-type: none"> • Press FL DIMMER on the remote control repeatedly to return to the default. |

**Note**

If the unit does not operate normally due to external effects such as static electricity disconnect the power plug from the outlet and insert again to return to normal operating conditions.

Specifications

Amplifier Section

Continuous average power output of 100 watts* per channel, min., at 8 ohms, from 20 Hz to 20,000 Hz with no more than 0.2%** total harmonic distortion (front).

Continuous Power Output (Stereo)

Front 100 W per channel
(20–20,000 Hz, THD 0.2 %, 8 Ω)

Continuous Power Output (Surround)

Front 100 W per channel
(1kHz, THD 1.0 %, 8 Ω)
Center 100 W (1kHz, THD 1.0 %, 8 Ω)
Surround 100 W per channel
(1kHz, THD 1.0 %, 8 Ω)

Input (Sensitivity/Impedance)

CD, VCR/DVR, CD-R/TAPE/MD,
DVD/LD, TV/SAT 200 mV/47 kΩ

Frequency Response

CD, VCR/DVR, CD-R/TAPE/MD, DVD/LD,
TV/SAT 5 Hz to 100,000 Hz ± 3 dB

Output (Level/Impedance)

VCR/DVR REC, CD-R/TAPE/MD REC
..... 200 mV/2.2 kΩ

Tone Control

BASS ± 6 dB (100 Hz)
TREBLE ± 6 dB (10 kHz)
LOUDNESS +6.5 dB/+3 dB (100 Hz/10 kHz)
(at volume level –50 dB)

Signal-to-Noise Ratio (IHF, short circuited, A network)

CD, VCR/DVR, CD-R/TAPE/MD,
DVD/LD, TV/SAT 96 dB

Signal-to Noise Ratio [EIA, at 1 W (1 kHz)]

CD, VCR/DVR, CD-R/TAPE/MD,
DVD/LD, TV/SAT 79 dB

Video Section

Input (Sensitivity/Impedance)

VCR/DVR, DVD/LD, TV/SAT 1 V_{p-p}/75 Ω

Output (Level/Impedance)

VCR/DVR 1 V_{p-p}/75 Ω

Frequency Response

VCR/DVR, DVD/LD,
TV/SAT \Rightarrow MONITOR 5 Hz to 7 MHz ± 3 dB
Signal-to-Noise Ratio 55 dB
Cross Talk 55 dB

FM Tuner Section

Frequency Range 87.5 MHz to 108 MHz
Usable Sensitivity Mono:13.2 dBf, IHF
(1.3 μ V/ 75 Ω)
50 dB Quieting Sensitivity Mono: 20.2 dB
Stereo: 38.6 dBf
Signal-to-Noise Ratio Mono: 73 dB
(at 85 dBf)
Stereo: 70 dB (at 85 dBf)
Distortion Stereo: 0.5 % (1 kHz)
Alternate Channel Selectivity 60 dB
(400 kHz)
Stereo Separation 40 dB (1 kHz)
Frequency Response 30 Hz to 15 kHz
(± 1 dB)
Antenna Input (DIN) 75 Ω unbalanced

AM Tuner Section

Frequency Range 530 kHz to 1,700 kHz
Sensitivity (IHF, Loop antenna) 350 μ V/m
Signal-to-Noise Ratio 50 dB
Antenna Loop antenna

Miscellaneous

| | |
|--------------------------------|--|
| Power Requirements | AC 120 V, 60 Hz |
| Power Consumption | 260 W |
| In Standby | 1.0 W |
| AC Outlet | 100 W MAX. (SWITCHED) |
| Dimensions | |
| | 420 (W) x 158 (H) x 393 (D) mm |
| | (16-9/16 (W) x 6-4/16 (H) x 15-8/16 (D) in.) |
| Weight (without package) | 9.0 kg |
| | (19.8 lb) |

Furnished Parts

| | |
|---|---|
| AM loop antenna | 1 |
| FM wire antenna | 1 |
| Dry cell batteries (AA size IEC R6) | 2 |
| Remote control | 1 |
| Operating instructions | 1 |



Note

Specifications and the design are subject to possible modifications without notice, due to improvements.

* Measured pursuant to the Federal Trade Commission's Trade Regulation rule on Power Output Claims for Amplifiers.

** Measured by Audio Spectrum Analyzer.



Dear Customer:

Selecting fine audio equipment such as the unit you've just purchased is only the start of your musical enjoyment. Now it's time to consider how you can maximize the fun and excitement your equipment offers. This manufacturer and the Electronic Industries Association's Consumer Electronics Group want you to get the most out of your equipment by playing it at a safe level. One that lets the sound come through loud and clear without annoying blaring or distortion-and, most importantly, without affecting your sensitive hearing.

Sound can be deceiving. Over time your hearing "comfort level" adapts to higher volumes of sound. So what sounds "normal" can actually be loud and harmful to your hearing. Guard against this by setting your equipment at a safe level BEFORE your hearing adapts.

To establish a safe level:

- Start your volume control at a low setting.
- Slowly increase the sound until you can hear it comfortably and clearly, and without distortion.

Once you have established a comfortable sound level:

- Set the dial and leave it there.

Taking a minute to do this now will help to prevent hearing damage or loss in the future. After all, we want you listening for a lifetime.

We Want You Listening For A Lifetime

Used wisely, your new sound equipment will provide a lifetime of fun and enjoyment. Since hearing damage from loud noise is often undetectable until it is too late, this manufacturer and the Electronic Industries Association's Consumer Electronics Group recommend you avoid prolonged exposure to excessive noise. This list of sound levels is included for your protection.

Decibel Level Example

| | |
|----|---|
| 30 | Quiet library, soft whispers |
| 40 | Living room, refrigerator, bedroom away from traffic |
| 50 | Light traffic, normal conversation, quiet office |
| 60 | Air conditioner at 20 feet, sewing machine |
| 70 | Vacuum cleaner, hair dryer, noisy restaurant |
| 80 | Average city traffic, garbage disposals, alarm clock at two feet. |

THE FOLLOWING NOISES CAN BE DANGEROUS UNDER CONSTANT EXPOSURE

| | |
|-----|---|
| 90 | Subway, motorcycle, truck traffic, lawn mower |
| 100 | Garbage truck, chain saw, pneumatic drill |
| 120 | Rock band concert in front of speakers, thunderclap |
| 140 | Gunshot blast, jet plane |
| 180 | Rocket launching pad |

Information courtesy of the Deafness Research Foundation.



S001 en



Should this product require service in the U.S.A. and you wish to locate the nearest Pioneer Authorized Independent Service Company, or if you wish to purchase replacement parts, operating instructions, service manuals, or accessories, please call the number shown below.

8 0 0 - 4 2 1 - 1 4 0 4

Please do not ship your product to Pioneer without first calling the Customer Support Division at the above listed number for assistance.

Pioneer Electronics (USA) Inc.
Customer Support Division
P.O. BOX 1760, Long Beach,
CA 90801-1760, U.S.A.

For warranty information please see the Limited Warranty sheet included with your product.

Should this product require service in Canada, please contact a Pioneer Canadian Authorized Dealer to locate the nearest Pioneer Authorized Service Company in Canada.

Alternatively, please contact the Customer Satisfaction Department at the following address:

Pioneer Electronics of Canada, Inc.
Customer Satisfaction Department
300 Allstate Parkway, Markham, Ontario L3R OP2
(905)479-4411
1(877)283-5901

For warranty information please see the Limited Warranty sheet included with your product.

Si ce produit doit être réparé au Canada, veuillez vous adresser à un distributeur autorisé Pioneer au Canada pour obtenir le nom du Centre de Service Autorisé Pioneer le plus près de chez-vous. Vous pouvez aussi contacter le Service à la clientèle de Pioneer:

Pioneer Electroniques du Canada, Inc.
Service à la clientèle
300, Allstate Parkway, Markham, Ontario L3R OP2
(905)479-4411
1(877)283-5901

Pour obtenir des renseignements sur la garantie, veuillez vous reporter au feuillet sur la garantie restreinte qui accompagne le produit.

S018D_enfr

Published by Pioneer Corporation.
Copyright © 2002 Pioneer Corporation.
All rights reserved.

PIONEER CORPORATION

4-1, Meguro 1-Chome, Meguro-ku, Tokyo 153-8654, Japan

PIONEER ELECTRONICS (USA) INC.

P.O. BOX 1540, Long Beach, California 90810-1540, U.S.A. TEL: (800) 421-1404

PIONEER ELECTRONICS OF CANADA, INC.

300 Allstate Parkway, Markham, Ontario L3R OP2, Canada TEL: (905) 479-4411

PIONEER EUROPE NV

Haven 1087, Keetberglaan 1, B-9120 Melsele, Belgium TEL: 03/570.05.11

PIONEER ELECTRONICS ASIACENTRE PTE. LTD.

253 Alexandra Road, #04-01, Singapore 159936 TEL: 656-472-1111

PIONEER ELECTRONICS AUSTRALIA PTY. LTD.

178-184 Boundary Road, Braeside, Victoria 3195, Australia, TEL: (03) 9586-6300

PIONEER ELECTRONICS DE MEXICO S.A. DE C.V.

Bldv.Manuel Avila Camacho 138 10 piso Col.Lomas de Chapultepec, Mexico,D.F. 11000 TEL: 55-9178-4270

K002E